

ALMA light

ALMA light
Barcelona

Catálogo general

General catalogue

2026





ALMA light
Barcelona

desde since 1989

Quién es

Josep Novell (Barcelona 1953)

Héctor Serrano (Valencia 1974)

Ernest Perera (Barcelona 1974)

Jordi Llopis (Barcelona 1972)



Josep Novell

Estudia Diseño de Producto en ELISAVA (Escuela Universitaria de Diseño e Ingeniería de Barcelona), y posteriormente se gradúa en Bachelor of Arts por la University of Southampton (Reino Unido). Desde 1980 se dedica al diseño, tanto desde su propio estudio como en colaboración con otros diseñadores. En 1984 funda la empresa "Via Design", junto con Joan Suñol, proyecto que finaliza en 1988. Posteriormente crea "Novell/Puig Design" junto con el diseñador Josep Puig. Además, desde 1984 imparte clases como profesor de proyectos en la Escuela Superior de Diseño ELISAVA. Es miembro de la Asociación de Diseño Industrial del Foment de les Arts i del Disseny (ADI-FAD). Josep Novell está particularmente interesado en relacionar estrechamente tres conceptos: forma, material y proceso de fabricación. Además tiene muy en cuenta aspectos más intangibles del producto como la comunicación, la emoción o la ética. Sus diseños están presentes en ámbitos tan diferentes como la iluminación, el packaging, el diseño de producto, el mobiliario o la imagen corporativa. Josep Novell es uno de los grandes diseñadores de nuestro país, y muchas de sus creaciones han sido galardonadas y expuestas en ferias y certámenes de diseño en Europa, Estados Unidos y Asia.

Héctor Serrano

Estudia Diseño Industrial en la UCHCEU de Valencia y más tarde cursa un Máster en Diseño de producto en el Royal College of Art de Londres. Héctor Serrano funda su oficina de diseño en Londres en el 2000, un estudio enfocado en crear productos y espacios con los que las personas se sientan atraídas de la manera más humana, emocional y extraordinaria posible. La búsqueda por aportar

innovación y carácter manteniendo la atemporalidad, sencillez y atención al detalle, es la constante en cada uno de sus proyectos. Entre sus clientes se encuentran firmas e instituciones como Muji, FontanaArte, Fundación La Caixa, Fundación Telefónica, Roca, Noken by Porcelanosa, Gandía Blasco, ICEX (Ministerio de Industria, Turismo y Comercio de España), Droog Design, Lexion, Lékué, Coachella Art and Music Festival, Metalarte and La Casa Encendida (Caja Madrid) entre otros. El estudio ha recibido varios premios como el Red Dot Design Award, Premio al Diseñador del Año 2009 por la prestigiosa revista AD, Best of the Year Awards de la revista Interior Design Magazine, el Peugeot Design Award y Madrid Concept Bus de EMT Madrid, así como el segundo premio para el diseño del nuevo autobús de Londres con Enrique Miñarro, Joaquín García y Javier Esteban. Sus productos se han expuesto extensamente en Museos como el V&A en Londres y Cooper-Hewitt National Design Museum en Nueva York y forman parte de varias colecciones como la del Central Museum de Amsterdam. En el 2010 Hector funda Borealis, la compañía encargada de sus proyectos de exposiciones e instalaciones. Compatibiliza su actividad profesional impartiendo clases y conferencias en universidades como ECAL en Lausanne, RCA de Londres, CEU en Valencia y IE en Madrid.

Ernest Perera

Ernest Perera combina sus estudios de escultura en la Facultad de Bellas Artes de la Universidad de Barcelona con los de Diseño Industrial en la Escuela ELISAVA (Escuela Universitaria de

Diseño e Ingeniería) de la misma ciudad.

Funda su propio estudio en 1999, donde diseña productos y experiencias para ayudar a las empresas a ser más competitivas, desde piezas únicas a elementos altamente seriados. Sus trabajos se caracterizan por proporcionar conceptos renovados en cada proyecto, aportando soluciones específicas para cada caso. En 2006 crea "Amor de Madre", su propia empresa editora de productos para el hogar, la cual le permite imprimir su libertad de creación y de experimentación en diversos productos del ámbito del hogar. Desde 1998 es docente en varias universidades de diseño de Barcelona. Actualmente es el Jefe de Área de Diseño de Productos en la escuela LCI Barcelona.

Ha colaborado con empresas como Camper, Lékué, Delica, Mago Urban, Alma Light –donde desarrolla junto a Josep Novell las colecciones BLOW, FLAT, MOON, ORB, PILL y SQUARE–, Museo Picasso de Barcelona, Runitag, Artesanía de Cataluña o el ADI-FAD. Ha recibido diversos galardones, como una selección a los Premios DELTA de Diseño ADI-FAD, Barcelona (2009) y el primer premio en el certamen internacional Les Découvertes, Maison Objet, París (2008).

Sus creaciones han sido expuestas en galerías de todo el mundo y han sido seleccionadas para diversas publicaciones sobre diseño internacional.

Jordi Llopis

Se forma como diseñador en la Escuela ELISAVA de Barcelona y en el 'Royal College of Art' de Londres.

Diseñador Industrial, ha trabajado como Design Manager en empresas de iluminación, llevando a cabo la dirección de nuevos productos e identidad corporativa. Lleva años colaborando con empresas de iluminación, mobiliario urbano y objetos para el hogar. 'Lifelight', lámpara creada por él en 2003, forma parte de la colección permanente del 'Museu del Disseny' de Barcelona, y su lámpara 'Clipa'm' fue seleccionada en los Premios Delta 2016.

Actualmente dirige su propio estudio de diseño llamado Jordi Llopis Design, en Barcelona, y es co-fundador de la editora Brots. Trabaja desarrollando nuevos diseños para el mundo de la iluminación y elementos urbanos, así como diseñando y produciendo sus nuevas colecciones para Brots. La excusa es diseñar para uno mismo como autoencargo, sin premisas ni filtros previos, para poder llegar a un producto muy personal, original y coherente que ofrecer. Esta es parte de la filosofía que se quiere transmitir en Brots. Jordi Llopis colabora, además, como profesor externo en ESDI, Escuela Superior de Diseño de Barcelona y ELISAVA Alumni y es tutor en el Máster de ESdesign Barcelona. Ha sido jurado en los Premios Eil de ELISAVA de Barcelona, y ha impartido talleres en la Universidad de Aguascalientes en México y en ELISAVA.

Who is

Jordi Llopis (Barcelona 1972)

Ernest Perera (Barcelona 1974)

Héctor Serrano (Valencia 1974)

Josep Novell (Barcelona 1953)



Ernest Perera

He combined his studies of sculpture in the Faculty of Fine Arts of the University of Barcelona with those of Industrial Design in ELISAVA (University School of Design and Engineering) of the same city.

He founded his own studio in 1999, where he designed products and experiences to help companies become more competitive, from unique pieces to highly serialized elements. His works are characterized by providing renewed concepts in each project, bringing specific solutions for each case. In 2006, he created "Amor de Madre", his own company for home products, which allows him to develop his freedom of creation and experimentation on various household products. Since 1998 he has been teaching at several design universities in Barcelona. He is currently the Head of Product Design at LCI Barcelona School.

He has collaborated with companies such as Camper, Lékué, Delica, Mago Urban, ALMA LIGHT - where he developed, together with Josep Novell, the collections BLOW, FLAT, MOON, ORB, PILL and SQUARE-, Barcelona Picasso Museum, Runitag, Artesanía de Cataluña or the ADI-FAD. He has received several awards, such as a selection at the DELTA Design Awards ADI-FAD, Barcelona (2009) and the first prize at the international competition Les Découvertes, Maison Objet, Paris (2008). His creations have been exhibited in galleries around the world and have been selected for various publications on international design.

Jordi Llopis

was formed as a designer at the ELISAVA School in Barcelona and at the 'Royal College of Art' in London. Industrial Designer, he has worked as a Design Manager in lighting companies carrying out the direction of new products and corporate identity. He has been collaborating with lighting companies, street furniture and household items for years. 'Lifelight', a lamp created by him in 2003, is part of the permanent collection of the 'Museu del Disseny' of Barcelona, and the 'Clipa'm' lamp was selected in the Delta 2016 Awards.

He currently directs his own design studio called Jordi Llopis Design, in Barcelona, and is co-founder of the editing company Brots. He works developing new designs in the world of lighting and urban elements, as well as designing and producing new collections for Brots. The excuse is to design for oneself on self-request, without prejudices or previous filters, in order to arrive at a very personal, original and coherent product to offer. This is part of the philosophy that to be transmitted by Brots. Jordi Llopis also collaborates as an external teacher at ESDI, Barcelona School of Design and ELISAVA Alumni and is Tutor in the ESdesign Barcelona Master. He has been a jury at the Ei Awards! of ELISAVA in Barcelona, and has collaborated in workshops at the University of Aguascalientes in Mexico and in ELISAVA.

creating products and spaces that people are attracted to in the most humane, emotional and extraordinary way possible.

The quest to bring innovation and character, while maintaining timelessness, simplicity and attention to detail, is a constant in each of his projects. The client list includes companies such as Muji, FontanaArte, La Caixa Foundation, Telefónica Foundation, Roca, Gandía Blasco, ICEX (Spanish Ministry of Industry, Tourism and Trade), Droog Design, Metalarte, Lékué, Lexon, Coachella Art and Music Festival and La Casa Encendida (Caja Madrid) among others. The office has received different awards such as the Red Dot Design Award, Designer of the Year 2009 by AD magazine, Best of the Year Awards by Interior Design Magazine, the Peugeot Design Award, Madrid Concept Bus (EMT Madrid) and the second prize on the New Bus for London Competition with Enrique Miñarro, Joaquín García and Javier Esteban. His products have been exhibited extensively in Museums such as V&A in London and Cooper-Hewitt National Design Museum in New York and are part of different collections as the Central Museum of Amsterdam. Hector founded the studio Borealis in 2010, the company responsible for his exhibition projects and installations. He currently combines his professional activity with teaching and giving lectures at universities as ECAL in Lausanne, RCA London, CEU in Valencia and IE in Madrid.

Josep Novell

He studied Product Design at ELISAVA (School of Design and Engineering of Barcelona) and he later graduated as Bachelor of Arts at the University of Southampton (United Kingdom).

Since 1980 he has been dedicated to design, both from his own studio and in collaboration with other designers.

In 1984 he founded the company "Via Design, SA" together with Joan Suñol, a project that ended in 1988. He later created "Novell / Puig Design" together with the designer Josep Puig. In addition, since 1984 teaches as a professor of projects in the School of Design ELISAVA. He is a member of the Industrial Design Association of the Foment de les Arts i del Disseny (ADI-FAD). Josep Novell is particularly interested in closely relating three concepts: form, material and manufacturing process.

He also takes into account more intangible aspects of the product such as communication, emotion or ethics.

His designs are present in areas as different as lighting, packaging, product design, furniture or corporate image. Josep Novell is one of the great designers of our country, and many of his creations have been awarded and exhibited in fairs and design contests in Europe, the United States and Asia.

Héctor Serrano

He studied Industrial Design at UCHCEU in Valencia before moving to London, where he took a master's degree in Product Design at the Royal College of Art. Héctor Serrano founded his own design office in London in 2000, a studio focused on

Quién es

Oriol LLahona (Barcelona 1977)

Josep Puig (Barcelona 1959)

Cristian Cubiñá (Barcelona 1968)

Alfonso de la Fuente (Valladolid 1974)



Oriol LLahona

Estudia Diseño Industrial en, Barcelona, Alemania y en el Reino Unido. Se gradúa en 1999 y obtiene su postgrado en 2004. Después de trabajar en diversas empresas y estudios de diseño, en 2004 crea su propio proyecto llamado "LLahona Design Studio" en el cual desarrolla su visión cosmopolita, contemporánea y positiva del diseño, la búsqueda de la esencia y las emociones en nuestra vida. Oriol LLahona es un diseñador nato, curioso y de mente abierta, su estilo es una mezcla de búsqueda de nuevos materiales y tecnologías con un sereno y refinado sentido de las formas. Sus diseños abarcan ámbitos tan diversos como la iluminación, el packaging, el diseño de producto, los espacios de restauración, el mobiliario. Muchas de sus creaciones han sido expuestas en salones de Italia, Alemania y Japón y han sido seleccionadas para diversas publicaciones sobre diseño internacional.

Josep Puig

Estudia Diseño Industrial en ELISAVA (Escuela Universitaria de Barcelona Diseño e Ingeniería) y obtiene el título en 1980. Posteriormente amplía su formación en la University of Southampton (Reino Unido) donde se gradúa con honores como Bachelor of Arts. Es miembro de la Asociación de Diseño Industrial del Fomento de las Artes y el Diseño ADI-FAD y ha formado parte de la Junta de la Asociación en diversas ocasiones. Ha impartido cursos y talleres en numerosos foros de diseño y actualmente es profesor en la Escuela Superior de Diseño ELISAVA, donde dirige el Máster en Diseño y Desarrollo de Producto en ELISAVA desde 2006. Josep Puig es un diseñador inquieto y brillante cuya creatividad se ha desarrollado en multitud de ámbitos. Entre

otras muchas iniciativas, es miembro fundador del grupo de diseño experimental "Transatlántic" junto a Ramón Benedito y Lluís Morillas. En 1989 se embarca en el proyecto "The Barna Crossing in Fukuoka" con Alfredo Arribas Arquitectos Asociados, para el diseño de una colección de objetos para un complejo multimedia en Fukuoka (Japón). Durante su trayectoria profesional ha recibido numerosos premios y distinciones de organismos españoles e internacionales. Junto al diseñador Josep Novell funda en 1992 el estudio "Novell/Puig Design", orientado al diseño y desarrollo de productos. En 2010 crea su propio estudio "Puig|Cabeza Design". Sus diseños, numerosos de ellos premiados en certámenes nacionales e internacionales, abarcan áreas tan variadas como los artículos sanitarios, gafas, packaging, cerámica y vidrio, electrodomésticos, mobiliario, iluminación y menaje del hogar.

Cristian Cubiñá

Estudia Diseño Industrial en la Escuela ELISAVA (Escuela Universitaria de Diseño e Ingeniería) de Barcelona y una vez finaliza su formación decide crear su proyecto empresarial, fundando la sociedad familiar "Hustadt Iluminación". Durante los primeros años asume las responsabilidades de Jefe de Producto. En 2003, momento en que la compañía crea la marca ALMA LIGHT, se responsabiliza de áreas más amplias como diseño de producto, selección de proveedores de proximidad y control de la fabricación y de sus estándares de máxima calidad, siempre con la vista puesta en la continua evolución del mercado, tanto en términos de diseño como en aspectos puramente tecnológicos y productivos. Es en el proyecto ALMA LIGHT donde Cristian Cubiñá puede desarrollar sus dotes de diseñador, proyectando los

stands de las ferias a las que la empresa acude como expositora, y creando colecciones y clásicas como la DROP o la LENS. Más adelante firmará otras creaciones, como las familias CANDLE, CAPSULE, DECO, HOTEL, KONE, LED BOX, LED OVAL, LED POLE, THE LIGHT y THE PALM. Sus diseños están impregnados de su carácter curioso y observador y en su afán por fijarse en todo lo que ve a su alrededor, donde cualquier detalle puede ser susceptible de convertirse en una luminaria. Cristian Cubiñá es uno de los diseñadores más reputados en el campo de la iluminación decorativa contemporánea, sector en el cual está especializado. Sus creaciones han sido expuestas en diversas ferias europeas y han sido seleccionadas para diversas publicaciones sobre diseño internacional.

Alfonso de la Fuente (Pichiglas Studio)

Afincado en Barcelona desde 1997, Alfonso de la Fuente ha ido evolucionando como artista autodidacta, aportando aires de renovación al panorama del diseño en el ámbito de la decoración a base de trabajo, talento, pasión e imaginación. Después de que su llegada a Barcelona le descubriese el reciclaje del plástico, Pichiglas empieza a reutilizar botellas de consumo masivo para crear objetos, creando su primer aparato de iluminación decorativa en 1997. Pichiglas se desarrolla entonces a gran velocidad gracias a la continua creatividad, a la pasión y al trabajo, produciendo siempre con humor, ironía y color, y convirtiéndose en partícipe de esa Barcelona tan de moda de los primeros años del siglo XXI en la que todo era posible. Después de cosechar un notable éxito con su línea de objetos decorativos y accesorios, el diseñador decide incluir en sus intereses el interiorismo integral para la decoración de bares de moda, restaurantes, comercios, locales y clubs, algunos convertidos ya en grandes clásicos como la discoteca barcelonesa FONFONE. El trabajo de Pichiglas Studio se da a conocer ya no sólo a nivel nacional, sino que empieza a recibir encargos de países como Francia e Italia. Lo que diferencia a Pichiglas Studio del resto de diseñadores es, precisamente, su capacidad para hacer de las texturas, los materiales y los objetos cotidianos verdaderas combinaciones de efectos visuales que no dejan a nadie indiferente. En una época en la que triunfa el minimalismo, Alfonso de la Fuente y Pichiglas Studio, revolucionan la decoración de los espacios con un denominador común: explosión de color combinada con una sorprendente simplicidad conceptual que consiguen un resultado de alto poder expresivo. En palabras del propio diseñador, "Hoy en día, tenemos que contar cosas cuando creamos, sorprender y chocar, pero sin perder nuestra esencia, aquello que nos define".

Who is

Alfonso de la Fuente (Valladolid 1974) Cristian Cubiñá (Barcelona 1968) Josep Puig (Barcelona 1959) Oriol LLahona (Barcelona 1977)



aspects. It is in the ALMA LIGHT project that Cristian Cubina can develop his skills as a designer, projecting the stands of the fairs in which the company participates as exhibitor and creating classic collections, such as DROP or LENS. Later, he signs other creations such as CANDLE, CAPSULE, DECO, HOTEL, KONE, LED BOX, OVAL LED, LED POLE, THE LIGHT and THE PALM. His designs are imbued with his curious and observant character and his eagerness to look at everything he sees around him, where any detail can be susceptible of becoming a light fitting. Cristian Cubina is one of the most renowned designers in the field of contemporary decorative lighting, a sector in which he is specialized. His creations have been exhibited at various European fairs and have been selected for several publications on international design.

Alfonso de la Fuente (Pichiglas Studio)
Based in Barcelona since 1997, Alfonso de la Fuente has evolved as a self-taught artist, bringing renewal airs to the design environment in the field of decoration based on work, talent, passion and imagination.

After his arrival in Barcelona, when finding out more about the recycling of plastic, Pichiglas begins to reuse bottles of mass consumption to create objects, designing his first decorative lighting fixture in 1997. Pichiglas develops then at high speed thanks to his continuous creativity, passion and work, always producing with humor, irony and color, and becoming a participant in that fashionable Barcelona of the first years of the 21st century in which everything was possible.

After reaping a remarkable success with his line of decorative objects and accessories, the designer decides to include in his interests the integral interior design for the decoration of trendy bars, restaurants, shops, stores and clubs, some of which have already become great classics such as the Barcelona disco FONFONE. The work of Pichiglas Studio is already known not only nationally, but begins to receive orders from countries such as France and Italy. What sets Pichiglas Studio apart from other designers is precisely its ability to make textures, materials and everyday objects true combinations of visual effects that leave no one indifferent. In an era in which minimalism triumphs, Alfonso de la Fuente and Pichiglas Studio revolutionize the decoration of spaces with a common denominator: explosion of color combined with a surprising conceptual simplicity that achieve a result of high expressive power.

In the words of the designer himself: "Today, we have to tell things when we create, we must surprise and collide, but without losing our essence, what defines us."

with Ramón Benedito and Lluís Morillas. In 1989 he embarked on the project "The Barna Crossing in Fukuoka" with "Alfredo Arribas Arquitectos Asociados", for the design of a collection of objects for a multimedia complex in Fukuoka, Japan. During his professional career he has received numerous awards and distinctions from Spanish and international organizations. Together with the designer Josep Novell founded in 1992 the study "Novell / Puig Design", oriented to the design and development of products. In 2010 he created his own studio "Puig [i] Cabeza Design". For ALMA LIGHT has developed, along with Josep Novell, collections of classic luminaires of the brand as STONE, SUN and TINY. Its designs, many of them awarded in national and international competitions, cover areas as varied as sanitary ware, glasses, packaging, ceramics and glass, household appliances, furniture, lighting and household items.

Cristian Cubiñá

He studies Industrial Design at the ELISAVA School (University School of Design and Engineering) in Barcelona and, once he finishes his training, he decides to create his own business project, founding the family society "Hustadt Iluminación". During the first years he undertakes the responsibilities of Product Manager.

In 2003, when the company creates the ALMA LIGHT brand, he becomes responsible for broader areas such as product design, selection of proximity suppliers and control of manufacturing and its highest quality standards, always with a view to the evolution of the market, both in terms of design and purely technological and productive

Oriol LLahona

He studied Industrial Design in Barcelona, Germany and the United Kingdom. He graduated in 1999 and obtained his postgraduate degree in 2004.

After working in various companies and design studios, in 2004 he created his own project called "LLahona Design Studio" in which he developed his cosmopolitan, contemporary and positive vision of design, the pursuit of essence and emotions in our life. Oriol LLahona is a born designer, curious and open-minded, his style is a mixture of searching for new materials and technologies with a serene and refined sense of forms. His designs cover areas as diverse as lighting, packaging, product design, dining spaces, furniture. Many of his creations have been exhibited in salons in Italy, Germany and Japan. They have also been selected for various publications on international design

Josep Puig

He studied Industrial Design at ELISAVA (Escuela Universitaria de Barcelona Diseño y Ingeniería) and obtained his degree in 1980. He later completed his degree at the University of Southampton (UK) where he graduated with honors as a Bachelor of Arts. He is a member of the Industrial Design Association of the Promotion of Arts and Design ADI-FAD and has been part of the Board of the Association on several occasions. He has taught courses and workshops in numerous design forums and is currently a professor at ELISAVA, where he has been leading the Master in Design and Product Development since 2006.

Josep Puig is a restless and brilliant designer whose creativity has developed in many areas. Among other initiatives, he is a founding member of the experimental design group "Transatlàntic"

Quién es

Andrea Gelpí (Barcelona 1991)



Iratxe González (Vitoria 1992)



Anna Salvans (Sabadell 1986)



Jose Manuel Mateo (Sabadell 1972)



Andrea Gelpí (Blaumel Studio)

Estudia diseño de producto en EINA Centro Universitario de Diseño y Arte de Barcelona. Posteriormente, decide ampliar sus conocimientos en el campo del mobiliario realizando un máster en Elisava Escuela Universitaria de Diseño e Ingeniería de Barcelona.

Durante la etapa del máster conoce a Iratxe González de Viñaspre junto con la cual, posteriormente, diseñan la lámpara de sobremesa Ophelia.

Ha tenido una amplia experiencia laboral trabajando en distintas empresas, estudios y marcas en las áreas de packaging, fachadas, producto y diseño de Luz.

Como diseñadora de iluminación adquiere un profundo conocimiento sobre la luz, como una materia intangible que tiene la capacidad para transformar espacios y sensaciones.

En 2020 funda su propio proyecto "Blaumel Studio", un espacio para conceptualizar, crear, sentir y diseñar productos con alma.

Iratxe González

Estudia Ingeniería en diseño industrial y desarrollo de producto en la Universidad de Mondragón para después empezar una nueva etapa en Barcelona, cursando el máster en Diseño de Mobiliario en Elisava Escuela Universitaria de Diseño e Ingeniería de Barcelona.

Durante esta etapa nace "En Salmón Mosataza" donde, junto a su compañera de máster y emprendedora Andrea Gelpí, inician su andadura en conjunto mientras diseñan la lámpara Ophelia. Como sus diseñadoras afirman, "Ophelia nace con el objetivo de no ser un simple envoltorio para la luz, sino una lámpara capaz de adaptarse a su usuario". Tras un periodo en conjunto, Iratxe decide embarcar un nuevo rumbo en

Danone como ingeniera y diseñadora de packaging, dando un giro relevante a su carrera. A día de hoy reside en Gante (Bélgica), donde lidera un equipo de desarrollo de packaging para las marcas Alpro y Danone a nivel Europeo.

Anna Salvans (Ozestudi)

Diseñadora industrial por la ESDI de Sabadell (Universitat Ramon Llull), donde se gradúa en 2008 y cursa licenciatura en el año 2012.

En 2012 entra a formar parte de Ozestudi, donde actualmente es socia y Codirectora de Proyectos. Su trayectoria la ha llevado a merecer diversos premios, destacando especialmente en el sector médico-farmacéutico y en el universo del sonido de alta fidelidad. Compagina su labor como diseñadora formando parte del equipo técnico en una importante empresa dedicada al diseño de mobiliario de lujo para boutiques de alta gama.

Funcionalista empedernida, busca siempre soluciones eficaces y optimizadas que persiguen hacer la vida de las personas más fácil y cómoda. Defiende que cada proyecto supone la oportunidad de poder entrar en un nuevo mundo de conocimiento, y que trabajar en sectores tan dispares, con clientes y encargos tan diferentes, le ha permitido mantener intacta su ilusión por el diseño: "investigar, aprender y solucionar".

Le apasiona la naturaleza, así como viajar y descubrir lugares nuevos de los que siempre extrae vivencias y reflexiones que utiliza con gran inteligencia para enriquecer su trabajo como diseñadora.

José Manuel Mateo (Ozestudi)

José Manuel Mateo obtiene el título de Diseñador Industrial por la Escola Llotja de Barcelona en el año 2000, graduándose como uno de los mejores alumnos de su

promoción.

En 1998 entra a formar parte como diseñador en la compañía Alutec del Vallés, una reconocida empresa de mobiliario en la cual actualmente es Director de Diseño, cargo que compagina con el de Codirector de Proyectos en Ozestudi, el estudio de diseño industrial y comunicación que él mismo funda a finales del s.XX.

Con más de 30 años dedicados al diseño, su trabajo ha recibido más de una veintena de premios, tanto nacionales como internacionales. Ha ejercido como jurado profesional en distintos certámenes y ha trabajado para más de 200 clientes, entre los que podemos destacar Lékué, Derbi, Wrigley, El Corte Inglés, Chupachups o Unilever, por citar solo algunos.

Cree firmemente en las bondades de un diseño que se establece como mediador entre las necesidades de la industria y las personas, con la sociedad como contexto a transformar. De mirada crítica, es también escritor, conferenciante y autor de muy diversas ponencias al respecto de la definición del diseño industrial y la sostenibilidad.

Who is

Jose Manuel Mateo (Sabadell 1972)

Anna Salvans (Sabadell 1986)

Iratxe González (Vitoria 1992)

Andrea Gelpí (Barcelona 1991)



José Manuel Mateo (Ozestudi)

José Manuel Mateo got the degree of Industrial Designer at the Escola Llotja in Barcelona in 2000, graduating as one of the best students in his class.

In 1998 he joined the company Alutec del Vallés as a Designer, a renowned furniture company in which he is currently Design Director, a position he combines with the post of Co-project Director at Ozestudi, the industrial design and communication studio he himself founded at the end of the 20th century.

With more than 30 years dedicated to design, his work has received more than twenty awards, both national and international. He has served as a professional jury in different contests, and has worked for more than 200 clients, among which we can highlight Lékué, Derbi, Wrigley, El Corte Inglés, Chupachups or Unilever, to name just a few.

He firmly believes in the benefits of a design that establishes itself as a mediator between the needs of the industry and people, with society as the context to transform. With a critical outlook, he is also a writer, lecturer and author of very diverse presentations regarding the definition of Industrial Design and sustainability.

packaging engineer and designer, making a significant shift in her career.

As of today, she resides in Ghent (Belgium), where she leads a packaging development team for the Alpro and Danone brands at a European level.

Anna Salvans (Ozestudi)

Anna Salvans is an Industrial Designer from the ESDi of Sabadell (Ramón Llull University), where she graduated in 2008 and completed her bachelor's degree in 2012.

In 2012 she joined Ozestudi, where she is currently a partner and Co-Project Director. Her career has led her to win various awards, standing out especially in the medical-pharmaceutical sector and in the universe of high-fidelity sound.

She combines her work as a Designer with being part of the technical team in an important company dedicated to the design of luxury furniture for high-end boutiques.

An inveterate functionalist, she always looks for effective and optimized solutions that aim to make people's lives easier and more comfortable. She says that each project represents the opportunity to enter a new world of knowledge, and that working in such various sectors, with such different clients and assignments, has allowed her to keep her enthusiasm for design intact: "investigate, learn and solve".

She is passionate about nature, as well as traveling and discovering new places from which she always extracts experiences and reflections that she uses with great intelligence to enrich her work as a designer.

Andrea Gelpí (Blaumel Studio)

She studied product design at EINA University Center of Design and Art of Barcelona. Later, she decided to expand her knowledge in the field of furniture by pursuing a master's degree at Elisava Barcelona School of Design and Engineering.

During the master's program, she met Iratxe González de Viñaspre, and together they later designed the Ophelia table lamp.

She has extensive work experience in different companies, studios and brands in the areas of packaging, facades, product design and lighting design. As a lighting designer, she has gained a deep understanding of light, as an intangible material that has the ability to transform spaces and evoke sensations.

In 2020 she founded her own project "Blaumel Studio", a space for conceptualizing, creating, experiencing, and designing products with soul.

Iratxe González

She studied Industrial Design Engineering and Product Development at Mondragon University before embarking on a new stage in Barcelona, while pursuing a master's degree in Furniture Design at Elisava Barcelona School of Design and Engineering.

During this period, "En Salmón Mosataza" was born, where she and her master's companion and entrepreneur Andrea Gelpí embarked on their journey together while designing the Ophelia lamp. As the designers themselves state, "Ophelia was created with the aim of not being a mere casing for light, but a lamp capable of adapting to its user."

After a period together, Iratxe decided to embark on a new path at Danone as a

Luminarias USB
USB Lamps

14 - 39





Sobremesas
Table Lamps

40 - 83



Lámparas de pie
Floor Lamps

84 - 125



Suspensiones
Hanging Lamps

125 - 221













Exterior
Outdoor

























288 - 297





 **Luminarias USB / USB Lamps** 14























Bell	30	 
Cuadrat	32	   *
Nautic	36	  *
Patio	20	  *
Tribeca USB	16	 

 **Sobremesas / Table Lamps** 40



























Aspen	82	
Candle	78	
Deco	76	   
Fuji	60	 
Hotel	80	  
MiniSpot	56	  
Ophelia	42	
Paros Alabaster	72	  
PotLight	50	
Star	68	 
Tribeca	64	   

 **Lámparas de pie / Floor Lamps** 84















Big Brother	116	
Deco	122	   

Fuji	102	  
Hotel	120	  
Led Pole	114	
Paros Alabaster	112	  
Pica	86	
Star	110	 
Tribeca	106	   
Totem I	98	
Totem II	94	  
Work	124	



























 **Suspensión / Hanging Lamps** 126

Bath A Led	208	  
Constellation	128	
Deco	196	    
Drop	216	 
Fuji	162	  
Led Box	198	
Led Oval	202	
Lens	210	 
Moon	192	  
Paros Alabaster	166	  
Stone	214	   *

Indice Index























SuperMoon	194	 
TheChandelier	186	
TheLight	188	
ThePalm	180	  
Totem II	138	  
Tribeca	156	   
Tribeca Chandelier	168	

Plafón / Ceiling Lamps 222





Bath A.....	242	
Deco	230	   
Drop S	226	 
Drop Downlight	250	
Lens	246	 
Mizu	244	 
Moon	232	  
Stone	240	   
SuperMoon	236	   
Tribeca.....	224	   

Apliques / Wall Lamps 252

Bath A Led	280	  
Flat Led	274	

Hotel	278	  
Madame	284	
MiniFlat	276	
MiniSpot	260	  
Mizu	282	 
Paros Alabaster	270	  
TheLight	272	 
Tribeca	262	    
Totem II	254	  

Exterior / Outdoor 288

Stone Out	294	 
Tiny	290	  

Luminarias USB USB Lamps

Bell / Cuadrat / Nautic / Patio / Tribeca USB









Tribeca USB

Design by Jordi LLopis

Pantalla alabastro
Shade alabaster

Estructura hierro galvanizado pintado epoxy texturizado
Structure galvanized iron textured epoxy painted

Luminaria con batería de polímero de Litio. Autonomía 8h, carga completa 5h. Cargador y cable USB no incluido (ver referencias abajo).

Led integrado. ON/OFF/Touch dimmer

Lithium polymer battery 8h autonomy. Complete charge 5h. Charger and USB cable not included (See codes below).
Integrated Led. ON/OFF/Touch dimmer

1800/011 24cm blanco texturizado **textured white**
1800/012 24cm corten texturizado **textured corten**
1800/018 24cm negro texturizado **textured black**

1810/011 20cm blanco texturizado **textured white**
1810/012 20cm corten texturizado **textured corten**
1810/018 20cm negro texturizado **textured black**

LED 1,3W 150lm 2700K CRI>90

9995/010 Cargador USB simple 5V 2A + cable USB de 1,5mt **Single 5V 2A charger + 1.5m USB cable**

9996/060 Cargador múltiple 5V 12A + 8 x cable USB de 1,5m **Multiple charger 5V 12A + 8 x 1.5m USB cable**

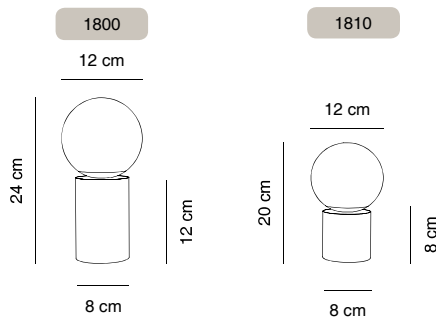

CE  IP 45









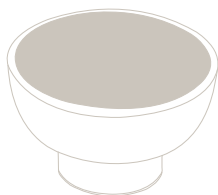

Elegante / Funcional
Fashionable / Useful



Los acabados de la luminaria PATIO, así como su diseño sereno y nada estridente, le confieren una gran elegancia aparte de su funcionalidad, al poderse colocar en cualquier sitio independientemente de tener una toma de corriente cercana. El difusor está fabricado en polietileno rotomoldeado en color natural y el cuerpo es de aluminio arenado y anodizado, disponible en dos versiones: plata y oro.

The finishes of the PATIO lamp, as well as its serene and smart design, give it great elegance apart from its functionality, as it can be placed anywhere regardless of having a plug nearby. The diffuser rotomoulded polyethylene in natural color and the body is made of sandblasted and anodized aluminium, available in two versions: silver and gold.

Se puede suministrar:

- Sin cable cargador ni cargador (se puede usar el de un teléfono móvil).
- Con 1 cargador y 1 cable USB para 1 luminaria.
- Con 1 cargador múltiple con 8 cables USB para cargar simultáneamente 8 luminarias.

It can be ordered:

- ***Whitout cable nor charger (the charger from a mobile phone can be used).***
- ***With 1 charger and 1 USB cable for 1 lamp***
- ***With 1 multiple charger and 8 USB cables to simultaneously charge 8 lamps.***





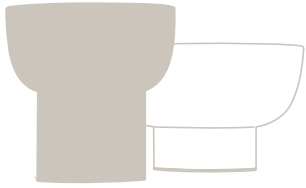

Usb / Inalámbrico **Usb / Wireless**



PATIO es una luminaria sin cables pensada para iluminar una mesa, ya sea en interior como en exterior, sin necesidad de disponer de una toma de corriente. Una aplicación ideal para hostelería y hotelería.

Utiliza una fuente de luz Led de 3W con un rendimiento máximo de 290 lúmenes. Gracias a su pantalla en polietileno rotomoldeado, esta luz se disipa homogéneamente iluminando el espacio sin sombras y la cubierta de aluminio anodizado evita el deslumbramiento de los comensales. Dispone de una batería de li-ion que permite una autonomía de máxima de 10 horas que se carga mediante un conector USB (igual que el de un teléfono móvil) situado en la base. También dispone de un pulsador de encendido, apagado y touch dimmer, para ajustar la luz según la necesidad de cada momento. La base dispone de unos toques de silicona para evitar que la luminaria se deslice, en caso que la superficie de apoyo no sea estable, como en caso de barcos o autocaravanas.



PATIO is a wireless lamp ideal for installations, designed to illuminate a table, either indoors or outdoors, without the need of a plug. Perfect for its use in hotels, restaurants, terraces...

It uses a 3W Led light source with a maximum output of 290 lumens. Thanks to its polyethylene rotomoulded shade, the light is dissipated evenly illuminating the space without shadows and the aluminium cover prevents the glare to the people sitting around the table. It houses a li-ion battery that allows 10 hours of autonomy, that is charged with a USB charger (like the ones used for mobile phones) located at the base. Besides it has an on-off switch and touch dimmer to adjust the light according to the needs of each moment. The base has silicone stoppers to prevent the luminaire to slide, in case the surface is not stable, as in boats or mobile homes.





Patio

Design by Oriol LLahona

Pantalla polietileno rotomoldeado
Shade rotomoulded polyethylene

Estructura aluminio anodizado
Structure anodized aluminium

Luminaria con batería Li-ion. Autonomía 8-10h. Carga completa 6h. Cargador y cable USB no incluido (ver referencias abajo).

Led integrado. ON/OFF dimmer 3 posiciones.

Lit-ion battery lamp. Autonomy 8-10h, full charge 6h. Charger and USB cable not included (See codes below). Integrated Led. ON/OFF 3 steps dimmer

2000/010 16,50cm dorado *gold*
2000/016 16,50cm plata *silver*

2010/010 12,50cm dorado *gold*
2010/016 12,50cm plata *silver*

LED 5V 1.2A - max. 3W 290lm 3000K CRI>80

9995/010 Cargador USB simple 5V 2A + cable USB de 1,5mt *Single 5V 2A charger + 1.5m USB cable*

9996/060 Cargador múltiple 5V 12A + 8 x cable USB de 1,5mt *Multiple charger 5V 12A + 8 x 1.5m USB cable*

2010/010
2010/016

2000/010
2000/016

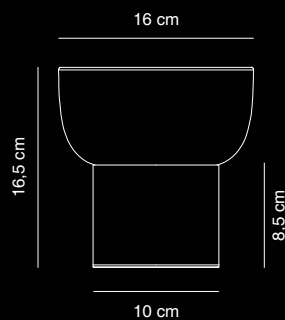
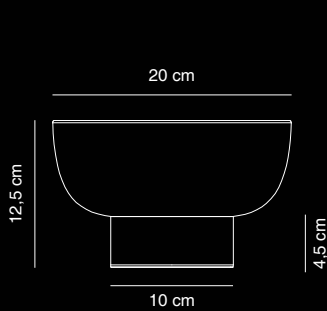

CE IP 44









Bell

Design by Cristian Cubiñá

Pantalla de latón arenado
Shade sandblasted brass

Estructura madera maciza de Iroco
Structure massive Iroco wood

Luminaria con batería de polímero de Litio. Autonomía 8h, carga completa 5h. Cargador y cable USB no incluido (ver referencias abajo).

Led integrado. ON/OFF/Touch dimmer

Lithium polymer battery 8h autonomy. Complete charge 5h. Charger and USB cable not included (See codes below)

Integrated Led. ON/OFF/Touch dimmer

2050/010

LED 1,3W 150lm 2700K CRI>90

9995/010 Cargador USB simple 5V 2A + cable USB de 1,5mt **Single 5V 2A charger + 1.5m USB cable**

9996/060 Cargador múltiple 5V 12A + 8 x cable USB de 1,5mt **Multiple charger 5V 12A + 8 x 1.5m USB cable**

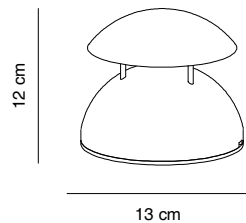

CE  IP 45











Cuadrat

Design by Josep Novell & Ernest Perera

Pantalla polietileno rotomoldeado
Shade rotomoulded polyethylene

Estructura de hierro pintado
Structure painted iron

Luminaria con batería de polímero de Litio. Autonomía 8h, carga completa 5h. Cargador y cable USB no incluido (ver referencias abajo). Led integrado. ON/OFF/Touch dimmer
Lithium polymer battery 8h autonomy. Complete charge 5h. Charger and USB cable not included (See codes below)
Integrated Led. ON/OFF/Touch dimmer

2160/011 blanco texturizado **textured white**
 2160/012 corren texturizado **textured corten**
 2160/018 antracita texturizado **textured anthracite**

LED 1,3W 150lm 2700K CRI>90

9995/010 Cargador USB simple 5V 2A + cable USB de 1,5mt
Single 5V 2A charger + 1.5m USB cable

9996/060 Cargador múltiple 5V 12A + 8 x cable USB de 1,5mt
Multi-charger 5V 12A 8 x 1.5m USB cable

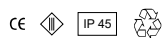
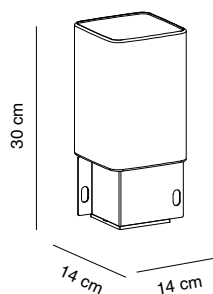





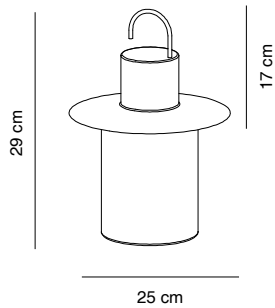

Nautic

Design by Josep Novell & Ernest Perera

Pantalla polietileno rotomoldeado
Shade rotomoulded polyethylene

Estructura de aluminio pintado texturizado
Structure textured painted aluminium

Luminaria con batería de polímero de Litio. Autonomía 8h, carga completa 5h. Cargador y cable USB no incluido (ver referencias abajo).

Led integrado. ON/OFF/Touch dimmer

Lithium polymer battery 8h autonomy. Complete charge 5h. Charger and USB cable not included (See codes below)
Integrated Led. ON/OFF/Touch dimmer

5210/011 blanco texturizado **textured white**

5210/012 corren texturizado **textured corten**

5210/018 antracita texturizado **textured anthracite**

LED 1,3W 150lm 2700K CRI>90

9995/010 Cargador USB simple 5V 2A + cable USB de 1,5mt **Single 5V 2A charger + 1.5m USB cable**

9996/060 Cargador múltiple 5V 12A + 8 x cable USB de 1,5mt **Multiple charger 5V 12A + 8 x 1.5m USB cable**

CE   



Sobremesas Table Lamps

Aspen / Candle / Deco / Fuji / Hotel / MiniSpot / Ophelia / Paros Alabaster / PotLight / Star / Tribeca













Ophelia

Design by Andrea Gelpí & Iratxe González

Pantalla de cuatro lamas orientables de metacrilato
Shade of four adjustable slats of methacrylate

Estructura de madera de roble con base en latón mate
Structure of oak wood with base in matt brass

Sin regulador. Versión regulable consultar
Without dimmer. Dimmable version: please contact us

Lámpara no incluida
Lamp not included

2030/018 pequeña, pantalla negra *small, black shade*
2031/018 grande, pantalla negra *large, black shade*

 E27 / E14 / LED

CE   IP20

2031

2030

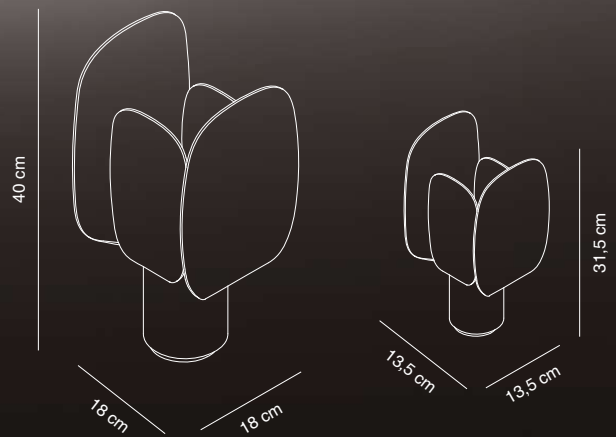



2031



2030

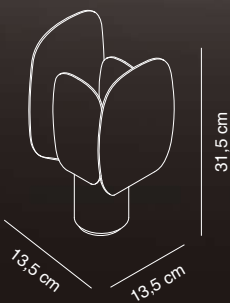
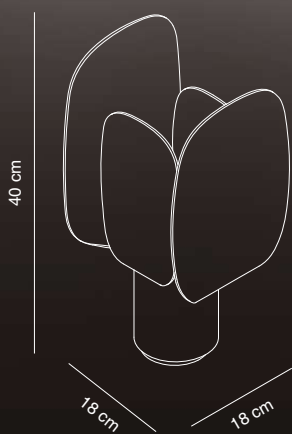

Ophelia

Design by Andrea Gelpí & Iratxe González

Pantalla de cuatro lamas orientables de metacrilato
Shade of four adjustable slats of methacrylate

Estructura de madera de roble con base en latón mate
Structure of oak wood with base in matt brass

Sin regulador. Versión regulable consultar
Without dimmer. Dimmable version: please contact us

Lámpara no incluida
Lamp not included

2030/011 pequeña, pantalla blanca **small, white shade**
2031/011 grande, pantalla blanca **large, white shade**

 E27 / E14 / LED

CE   IP20

Ophelia es una lámpara de sobremesa que permite al usuario generar diferentes ambientes, adaptando la pantalla de la manera deseada. Gracias a esta versatilidad y al regulador de intensidad integrado en el cable, el usuario consigue un total control sobre la iluminación requerida en cada momento. Las cuatro lamas que conforman la pantalla de Ophelia se sujetan a la base mediante la propia estructura de madera y rotan de modo independiente, generando grados de iluminación diferentes. Gracias al diseño de la sujeción y a la poca resistencia que ofrece el metacrilato al friccionar entre sí, se consigue una rotación muy limpia. Las dos lamas exteriores tienen un giro de 180° entre ellas; lo mismo sucede con las dos interiores, con lo cual el giro total de las cuatro lamas de la pantalla es de 360° .

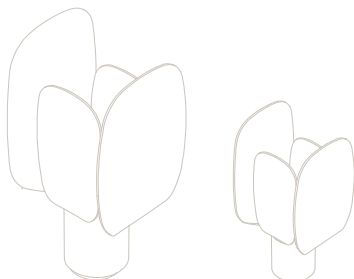

Ophelia is a table lamp that allows the user to create different environments, adapting the shade as desired. Thanks to this versatility and to the dimmer integrated into the cable, the user gets full control over the lighting at all times. The four slats that make up the Ophelia shade are attached to the base by the wooden structure itself and rotate independently, generating different degrees of lighting. Thanks to the design of the fastening and the little resistance offered by the methacrylate pieces when rubbing against each other, a very clean rotation is achieved. The two outer slats have a 180° turn between them; the same happens with the two inner ones, with which the total rotation of the four slats of the shade is 360° .













PotLight

Design by Josep Novell & Josep Puig

PotLight ofrece la posibilidad de modificar su aspecto gracias a los 2cm de espacio entre ambos cristales que permiten la personalización de la pantalla. Pueden depositarse una gran variedad de pequeños elementos cotidianos (no líquidos) entre ambos cristales, ofreciendo así variaciones infinitas que se pueden crear sin ningún esfuerzo

PotLight offers the possibility of modifying its appearance thanks to the 2cm of space between both glasses that allow customization of the shade. A wide variety of small everyday items (non-liquid) can be deposited between both glasses, thus offering infinite variations that can be created without any effort

Pantalla compuesta de un cristal de borosilicato transparente y un cristal de borosilicato arenado interior

Shade composed of one transparent borosilicate glass and one inner borosilicate sandblasted glass

Estructura cerámica / arcilla

Structure ceramics / clay

Dos tipos de relleno incluidos, virutas de madera y papel artesanal hecho a mano. **Two types of filler included, wood shavings and handmade craft paper**

Sin regulador. Versión regulable consultar **Without dimmer. Dimmable version: please contact us**

Lámpara no incluida **Lamp not included**

2460/012

 E27 LED

CE   IP 20

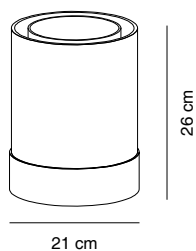



Júlia Esqué

En el marco de la Barcelona Design Week 2023, ALMA Light organizó un evento en la Galería H2O (Barcelona) con veintiún ejemplares de la lámpara de sobremesa PotLight. Los diseñadores y artistas invitados intervinieron sobre ellas, creando veintiún conceptos totalmente diferentes. De esta manera mostramos las infinitas posibilidades aplicables a la luminaria, tantas como se pueda llegar a imaginar.

As part of Barcelona Design Week 2023, ALMA Light organized an event at the Gallery H2O (Barcelona) with twenty-one units of the PotLight table lamp. The invited designers and artists intervened on them, creating twenty-one totally different concepts. Through this, we showed the infinite possibilities applicable to this light fixture, as many as one can possibly imagine.



Quim Larrea & Núria Gual



Joan Clop



Octavi Serra



Josep Puig



Marta Barangé



Martí Guixé



Ferran Morgui & Totoya Súnico



Jordi Sàbat



Gastón Lisak



Josette Trilla



Josep Novell



Maitè Oriol & Beppe Benenti



Glòria Montasell & Lluís Morillas



Isaac Salom



Ernest Perera



Juli & Cris Capella



Max Milà



Joaquim Ruiz



Maitè Prat & Ramon Benedito



Meritxell Gras







MiniSpot

Design by Cristian Cubiñá

Estructura hierro pintado texturizado
Structure iron textured painted

Regulable mediante touch dimmer
Dimmable by touch dimmer

Led integrado **Integrated Led**

2525/011 blanco **white**
2525/018 negro **black**

LED Cree 3W 260lm 3000K CRI>90

CE  

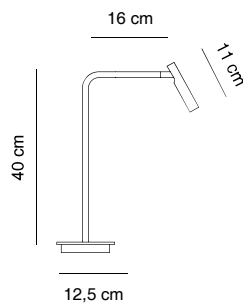







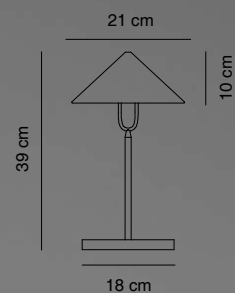

Fuji

Design by Jordi LLopis

Pantalla alabastro
Shade alabster

Estructura hierro baño electrolítico latón pulido
brillo
Structure iron with electrolytic bath in polished brass finish

Sin regulador. Versión regulable consultar
Without dimmer. Dimmable version: please contact us

Led integrado
Integrated Led

2070/010

LED Seoul 4,6W 260lm 2700K CRI>80

CE IP 20





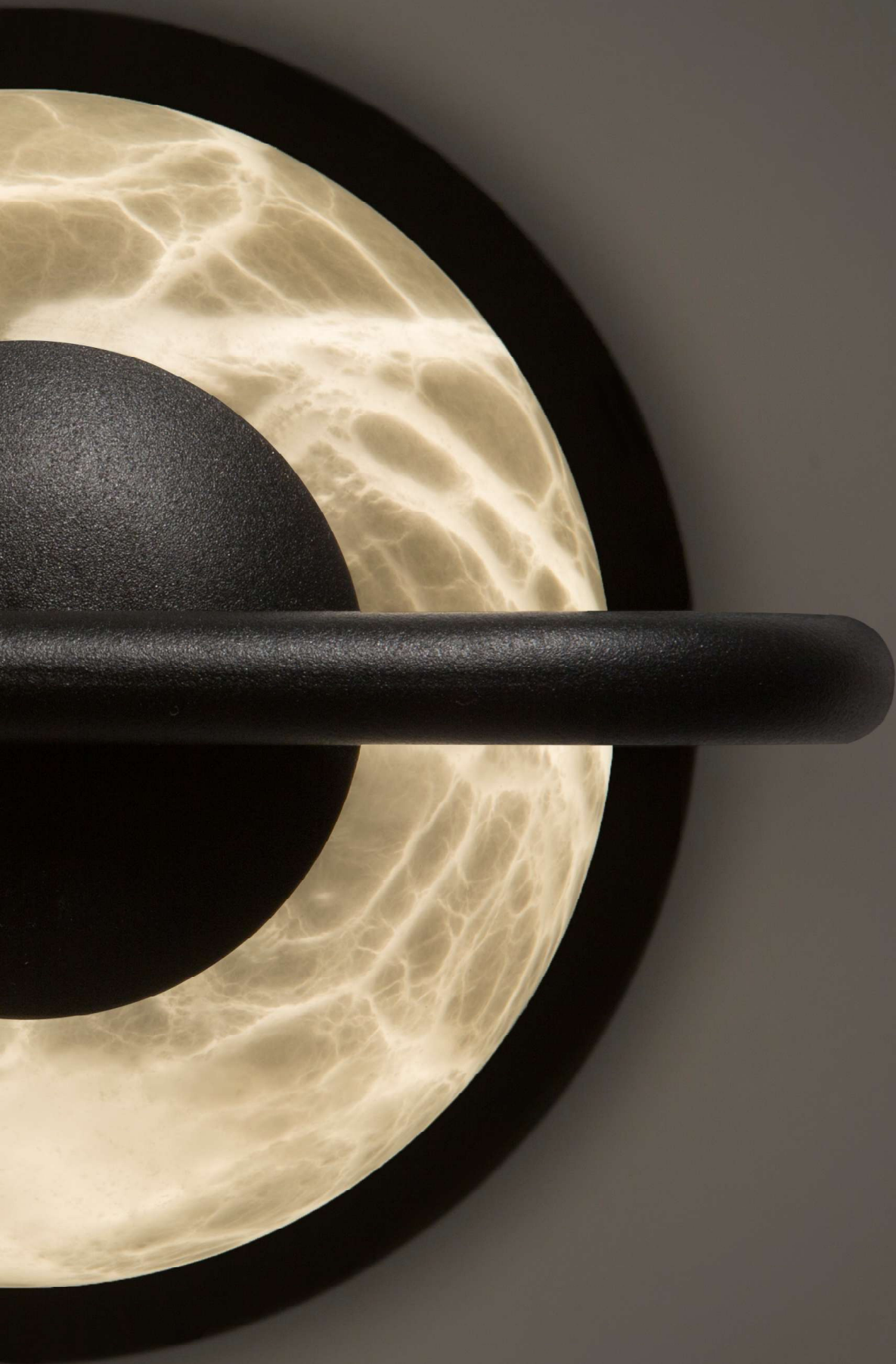

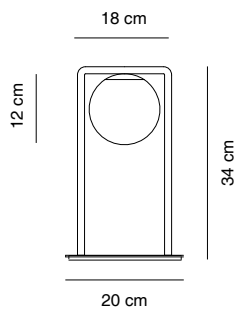

Tribeca

Design by Jordi LLopis

Pantalla alabastro
Shade alabaster

Estructura hierro pintado negro texturizado
Structure black textured painted iron

Led integrado
Integrated Led

No regulable **Not dimmable**
2800/018

Regulable **Dimmable**
2800/018RG

LED Seoul 4.5W 270lm 2700K CRI>80

CE IP 20



La otra mujer



Andreu Martín

Roberto Amparero Nuestros años verde olivo

El segundo círculo

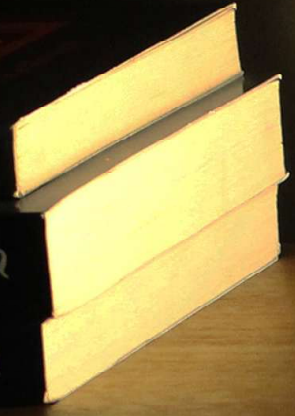





70 / Alma Light

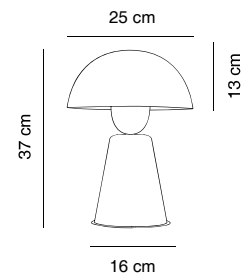

Star

Design by Cristian Cubiñá

Pantalla metacrilato opal
Shade opal methacrylate

Estructura hierro pintado brillante
Structure gloss iron painted

Sin regulador. Versión regulable consultar
Without dimmer. Dimmable version: please contact us

Lámpara no incluida
Lamp not included

2085/011 blanco brillante **glossy white**
2085/018 negro brillante **glossy black**

 E27 LED

CE  







Paros Alabaster

Design by Josep Novell & Ernest Perera

Pantalla alabastro
Shade alabaster

Estructura hierro pintado blanco texturizado
Structure textured white painted iron

Sin regulador. Versión regulable consultar
Without dimmer. Dimmable version: please contact us

Lámpara no incluida
Lamp not included

2270/011

 E14 LED

CE  

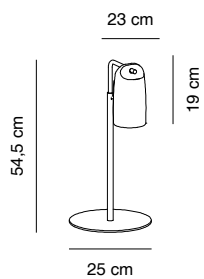







Deco

Design by Cristian Cubiñá

Pantalla cristal prensado de Bohemia en acabado transparente
Shade pressed Bohemia crystal in transparent finish

Estructura hierro
Structure iron

Sin regulador. Versión regulable consultar
Without dimmer. Dimmable version: please contact us

Lámpara no incluida
Lamp not included

2550/011 cromo **chrome**
2530/011 dorado brillo **polished gold**

 E14 LED

CE  

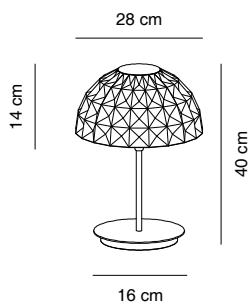





Candle

Design by Cristian Cubiñá

Cristal soplado triplex opal
Opal triplex blown glass

Regulador touch dimmer **With touch dimmer**

Led integrado
Integrated Led

- 2250/011 blanco texturizado **textured white**
- 2250/016 níquel satinado **satin nickel**
- 2250/017 cromo **chrome**

LED 6W 3000K

CE IP20

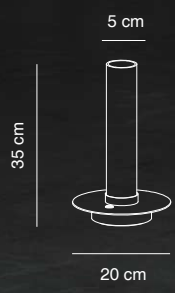



Hotel

Design by Cristian Cubiñá

Estructura hierro níquel satinado

Structure satin nickel iron

Pantalla algodón negro

Shade black cotton

Sin regulador. Versión regulable consultar

Without dimmer. Dimmable version: please contact us

Lámpara no incluida

Lamp not included

2540/018



E27 LED

CE  

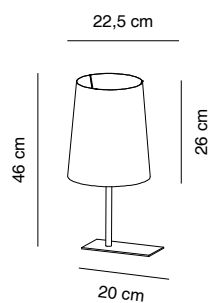





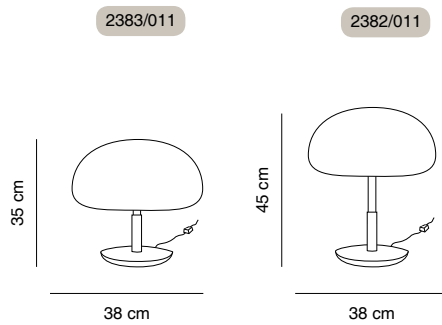

Aspen

Design by Javier Taberner & Nacho Poveda

Pantalla cerámica esmaltada brillante
Shade shiny enamelled ceramic

Estructura madera de roble y hierro pintado epoxy,
con cable textil
**Structure oak wood and epoxy painted iron, with
textile cable**

Sin regulador **Without dimmer**

Lámpara no incluida
Lamp not included

2382/011
2383/011

 3 x E14 LED

CE  

Lámparas de pie

Floor Lamps

Big Brother / Deco / Fuji / Hotel / Led Pole / Paros Alabaster / Pica / Star /
Tribeca / Totem I / Totem II / Work



















Pica

Design by Josep Novell & Josep Puig

Pantalla algodón con tapa de membrana plástica, regulable en altura
Shade cotton with plastic membrane cover, adjustable in height

Estructura hierro pintado antracita texturizado
Structure iron anthracite textured painted

Con interruptor, sin regulador **On/off switch, without dimmer**

Lámpara no incluida, reemplazable
Lamp not included, replaceable

3025/011 pantalla blanca **white shade**
3025/018 pantalla gris oscuro **dark grey shade**

 E27 LED

CE  IP 20

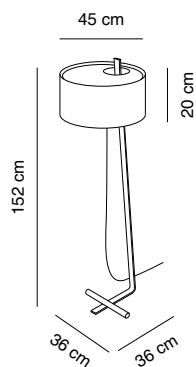





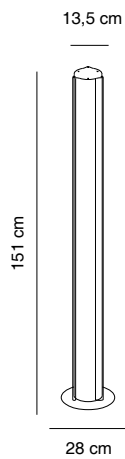

Totem II

Design by Cristian Cubiñá

Pantalla cristal de borosilicato estriado transparente
Shade transparent fluted borosilicate glass

Estructura hierro pintado texturizado o baño electrolítico
Structure textured painted or electroplated iron

Regulador con interruptor incluido en el cable
Switch - dimmer in cable included

Led integrado
Integrated Led

3333/012 bronce satinado **satin bronze**
3333/018 negro texturizado **textured black**

LED 230V 16W 1520lm 2700K CRI>90

CE  











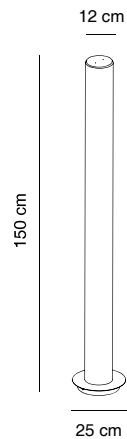
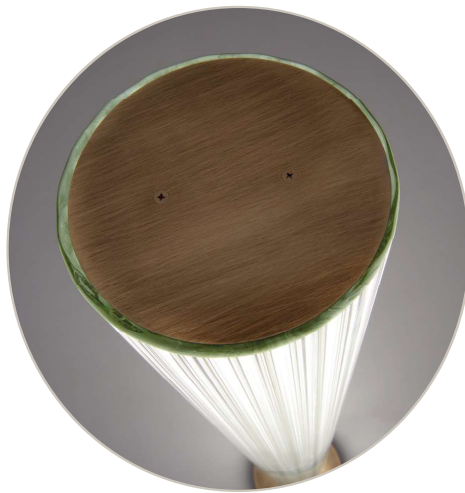
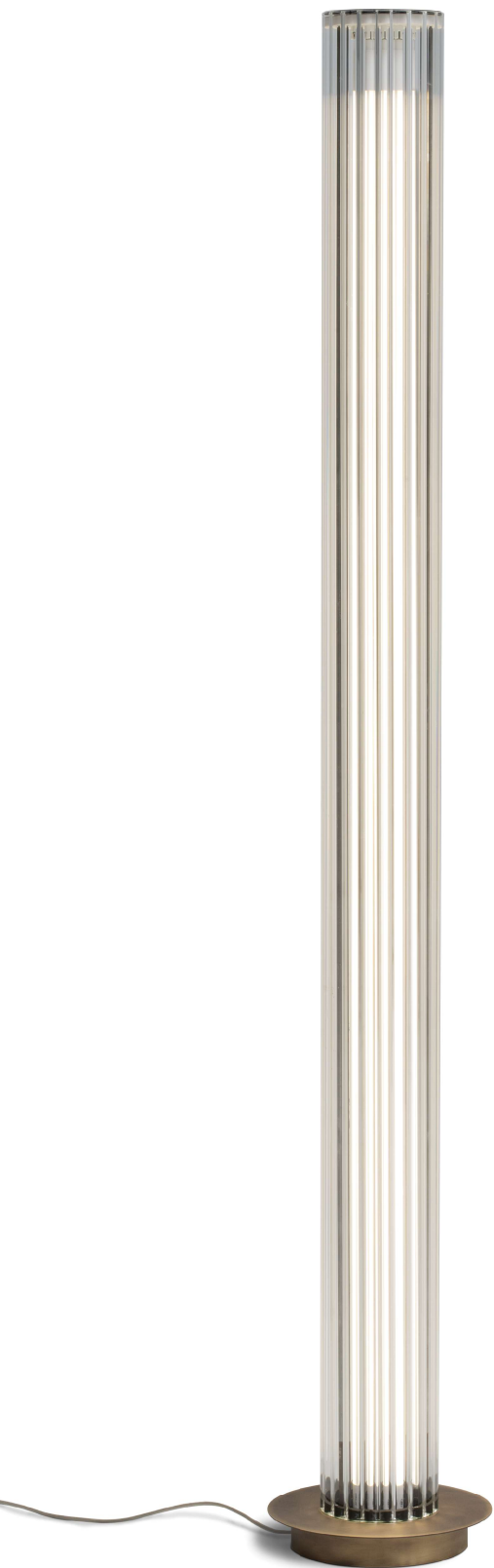

Totem I

Design by Cristian Cubiñá

Pantalla cristal de borosilicato estriado transparente
Shade transparent fluted borosilicate glass

Estructura: hierro pintado texturizado o baño electrolítico
Structure textured painted or electroplated iron

No regulable. Versión regulable: contactar
Not dimmable. Dimmable version: please contact us

Lámpara no incluida
Lamp not included

3000/012 bronce satinado **satin bronze**
3000/018 negro texturizado **textured black**

☐ G13 LED T8 150cm

CE IP 20







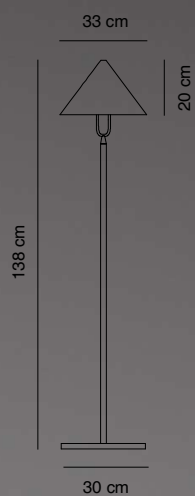
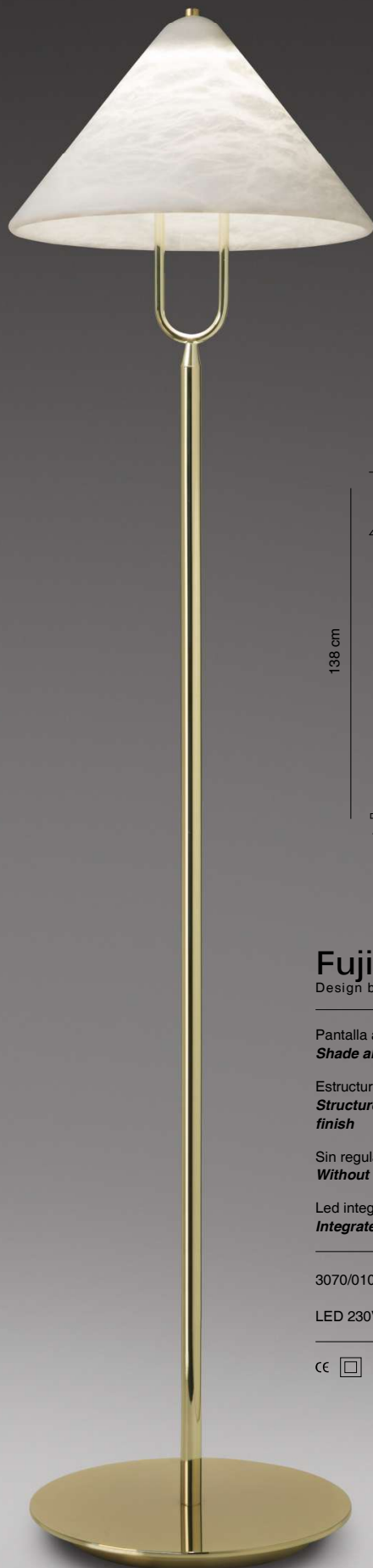

Fuji

Design by Jordi LLopis

Pantalla alabastro
Shade alabaster

Estructura hierro baño electrolítico latón pulido brillo
Structure iron with electrolytic bath in polished brass finish

Sin regulador. Versión regulable: consultar
Without dimmer. Dimmable version: please contact us

Led integrado
Integrated Led

3070/010

LED 230V 4,83W 335lm 2700K CRI>80

CE IP 20





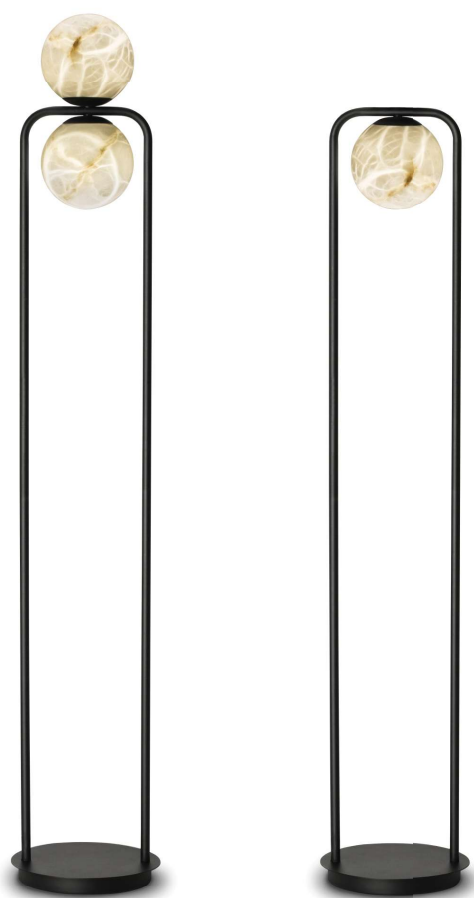

3800/018

3800/028

3810/028

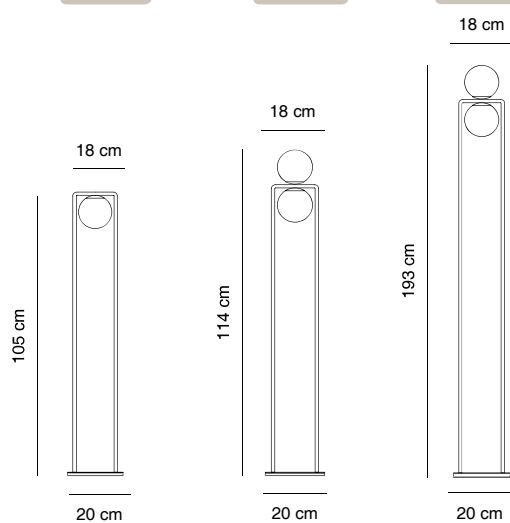

Tribeca

Design by Jordi LLopis

Pantalla alabastro

Shade alabaster

Estructura hierro pintado negro texturizado
Structure black textured painted iron

Sin regulador. Versión regulable: consultar
Without dimmer. Dimmable version: please contact us

Led integrado
Integrated Led

3800/018 105cm

3800/028 114cm

3810/028 193cm

LED Seoul 4.5W 270lm 2700K CRI>80

CE IP 20





110 / Alma Light



Star

Design by Cristian Cubiñá

Pantalla metacrilato opal
Shade opal methacrylate

Estructura hierro pintado brillante
Structure glossy iron painted

Sin regulador. Versión regulable consultar
Without dimmer. Dimmable version: please contact us

Lámpara no incluida
Lamp not included

3085/011 blanco brillante **glossy white**
3085/018 negro brillante **glossy black**

 E27 LED

CE  

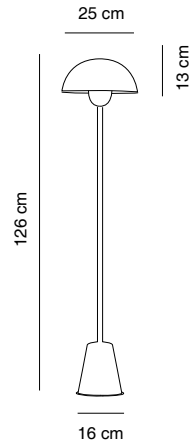





Paros Alabaster

Design by Josep Novell & Ernest Perera

Pantalla alabastro

Shade alabaster

Estructura hierro pintado blanco texturizado

Structure textured white painted iron

Sin regulador. Versión regulable consultar

Without dimmer. Dimmable version: please contact us

Lámpara no incluida, reemplazable

Lamp not included, replaceable

3270/011

 E14 LED

CE  

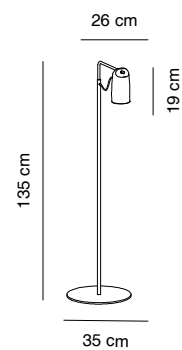

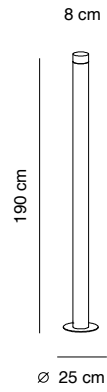

Led Pole

Design by Cristian Cubiñá

Pantalla metacrilato arenado
Shade sandblasted methacrylate

Estructura extrusión aluminio
Structure extruded aluminum

Regulador-interruptor incluido en el cable
Switch-dimmer in cable included

Led integrado
Integrated Led

3160/011 blanco texturizado **textured white**
3160/018 negro texturizado **textured black**

LED Talex Stark module 20W 3500lm 3000K CRI>90

CE  









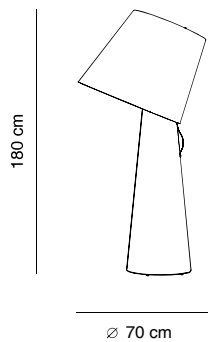

Big Brother

Design by Oriol LLahona

Pantalla textil de polipropileno blanco y asa en cuero grabado
Shade white polypropylene textile and engraved leather handle

Estructura hierro pintado blanco texturizado
Structure textured white painted iron

Regulador-interruptor incluido en el cable
Switch-dimmer in cable included

Lamparas no incluidas
Lamps not included

3950/011

 3 X E27 LED

CE  

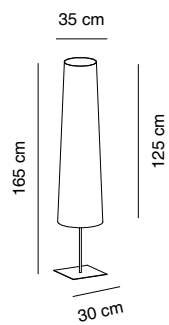

Hotel

Design by Cristian Cubiñá

Pantalla algodón negro
Shade black cotton

Estructura hierro níquel satinado
Structure satin nickel iron

Sin regulador. Versión regulable consultar
Without dimmer. Dimmable version: please contact us

Lámpara no incluida
Lamp not included

3540/018

 E27 LED

CE  



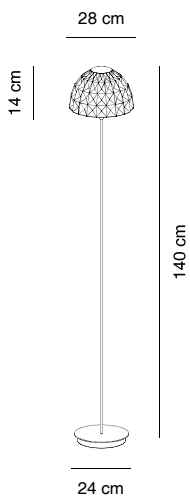
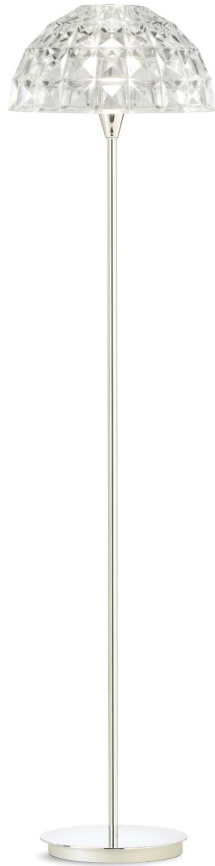

Deco

Design by Cristian Cubiñá

Pantalla cristal prensado de Bohemia en acabado transparente
Shade pressed Bohemia crystal transparent glass

Estructura hierro
Structure iron

Sin regulador. Versión regulable consultar
Without dimmer. Dimmable version: please contact us

Lámpara no incluida
Lamp not included

3550/011 cromo **chrome**
3530/011 dorado brillo **polished gold**

 E14 LED

CE  



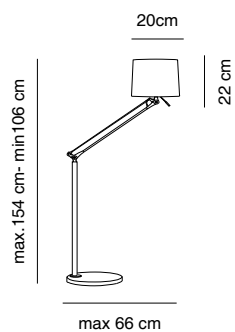

Work

Pantalla textil almadén plata
Shade silver almadén textile

Estructura aluminio anodizado plata mate
Structure aluminium matt silver anodized

Sin regulador **Without dimmer**

Lámpara no incluida
Lamp not included

4245/019

 E27 LED

CE  



Suspensiones Hanging Lamps

Bath A Led / Constellation / Deco / Drop Led / Fuji / Led Box / Led Oval / Lens
Led / Moon / Paros Alabaster / Stone Led / SuperMoon / TheChandelier /
TheLight / ThePalm / Totem II / Tribeca / Tribeca Chandelier



















Constellation

Design by Héctor Serrano

Estructura latón
Structure brass

Pantalla cristal triplex opal mate
Shade matt opal triplex glass

Lámparas no incluidas **Lamps not included**

Para crear luminarias adaptadas a tu proyecto, las longitudes de las tijas de suspensión pueden personalizarse entre longitudes de 15, 30, 58 y 100cm
Para otras medidas, consultar
Indicar las longitudes requeridas al momento de hacer el pedido

**In order to create luminaires better adapted to your project, the suspension rods can be customized between lengths of 15, 30, 58 and 100cm
For other lengths please contact us
Please specify the desired rod lengths when placing the order**

5120/048 negro texturizado **textured black**
5120/040 latón pulido brillo **polished brass**

5120/088 negro texturizado **textured black**
5120/080 latón pulido brillo **polished brass**

5120/128 negro texturizado **textured black**
5120/120 latón pulido brillo **polished brass**

 G9 LED

CE  

5120/04.

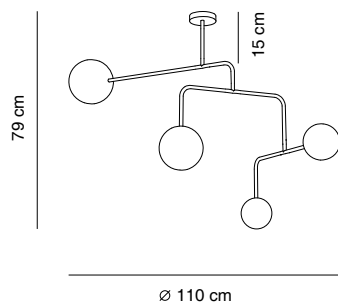

5120/08.

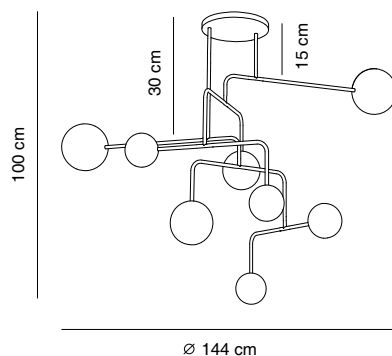

5120/12.

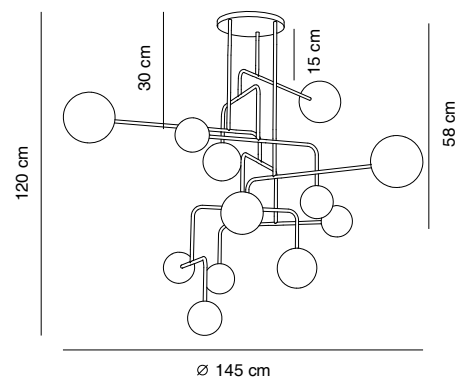











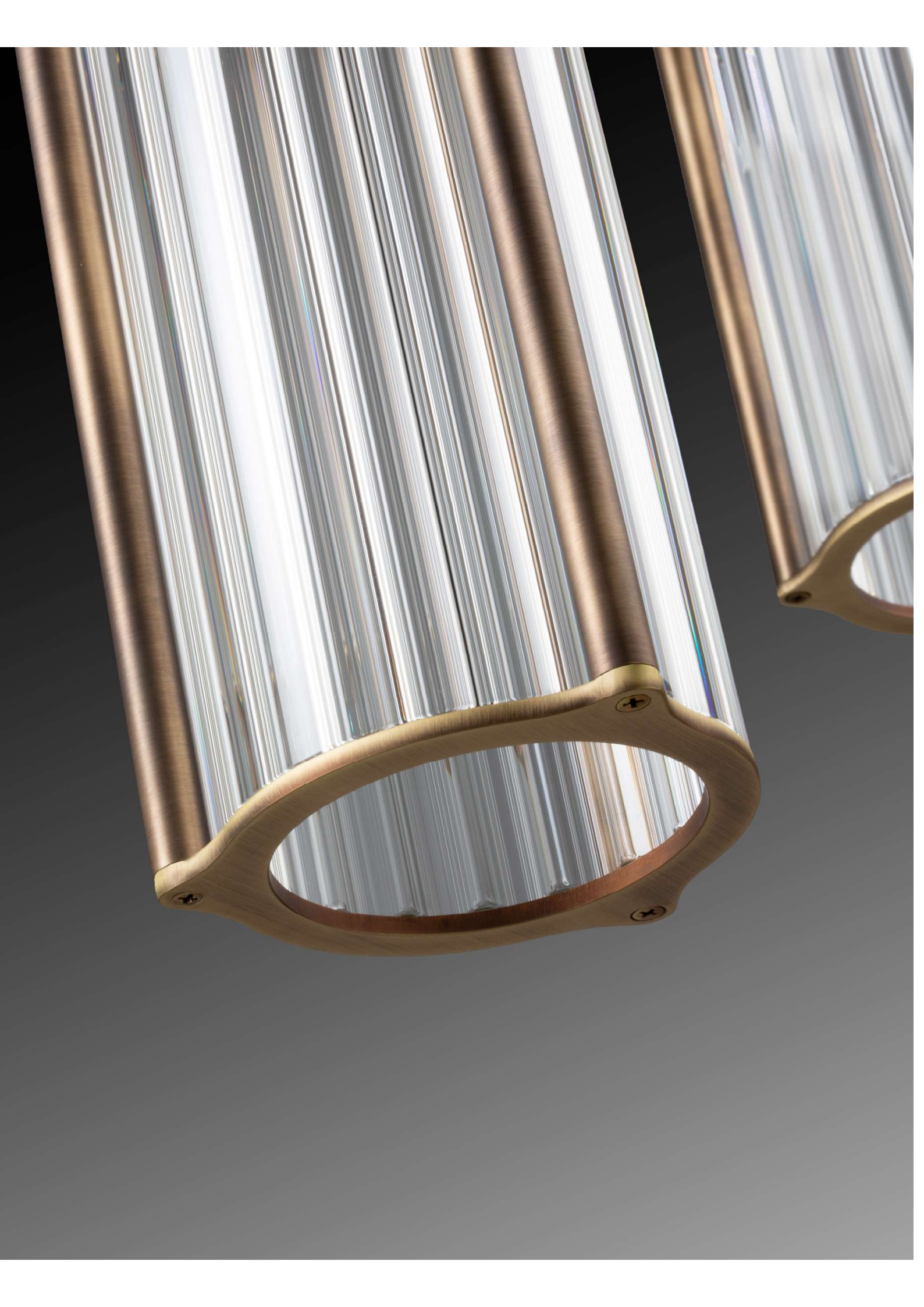



Totem II

Design by Cristian Cubiñá

Pantalla cristal de borosilicato estriado transparente
Shade transparent fluted borosilicate glass

Estructura hierro pintado texturizado o baño electrolítico
Structure textured painted or electroplated iron

Regulable mediante Triac
Dimmable by Triac

Led integrado
Integrated Led

5333/012 25cm 10W bronce satinado **satin bronze**
 5333/018 25cm 10W negro texturizado **textured black**
 5334/012 50cm 10W bronce satinado **satin bronze**
 5334/018 50cm 10W negro texturizado **textured black**

LED 230V 10W 920lm 2700K CRI>90

5335/012 25cm 16W bronce satinado **satin bronze**
 5335/018 25cm 16W negro texturizado **textured black**
 5336/012 50cm 16W bronce satinado **satin bronze**
 5336/018 50cm 16W negro texturizado **textured black**

LED 230V 16W 1520lm 2700K CRI>90

CE  IP 20

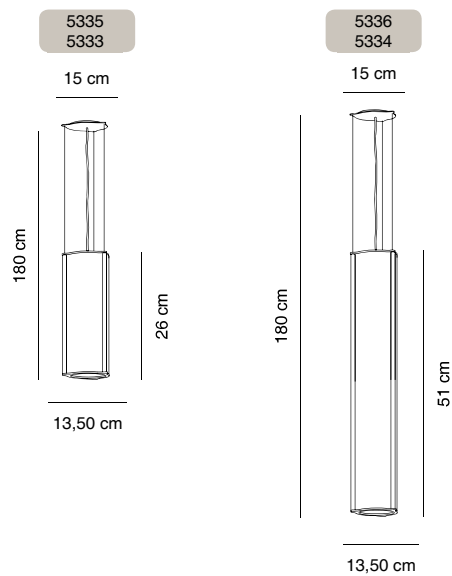

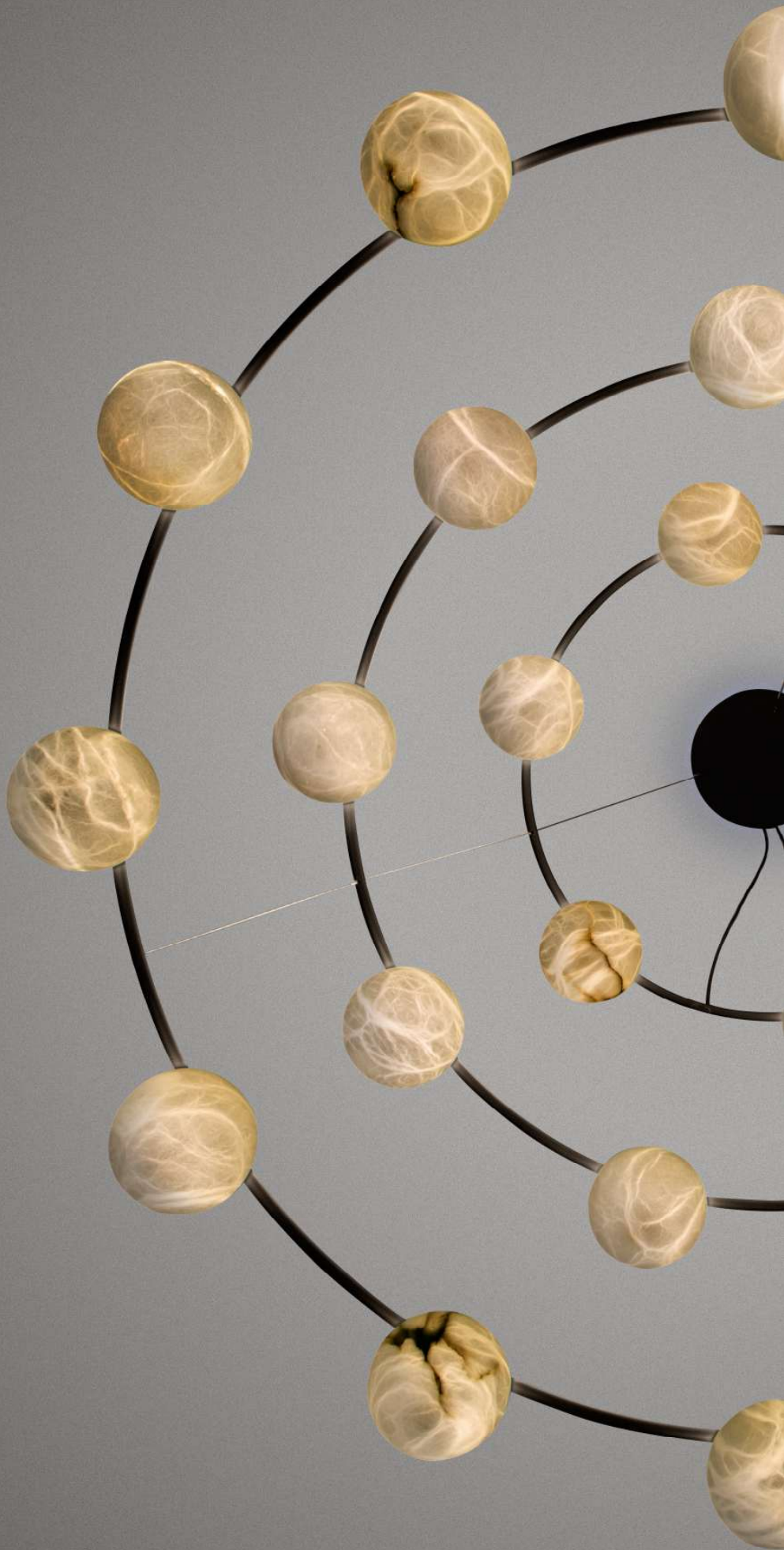













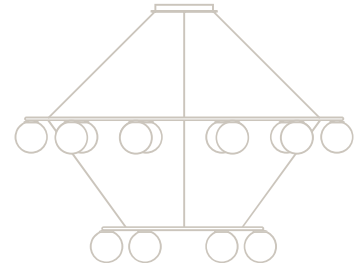
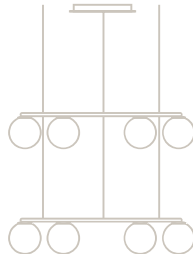
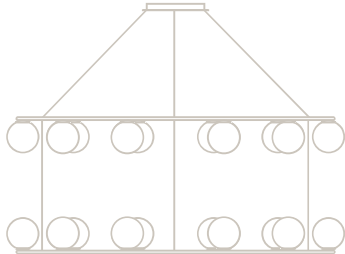
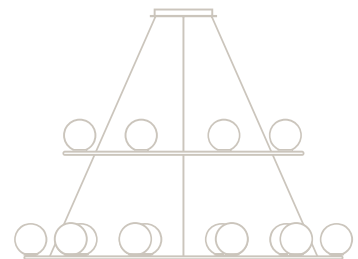
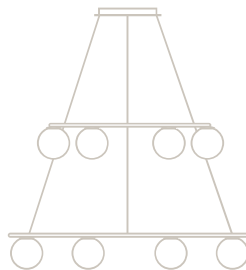
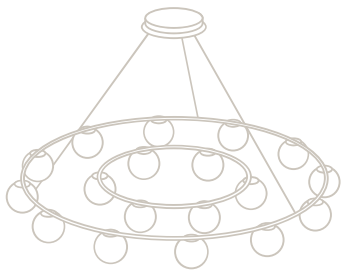
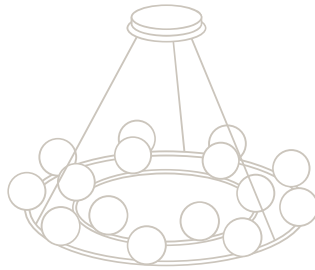
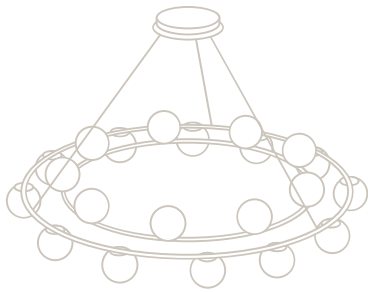

Tribeca Chandelier is a collection of large pendants that can be combined with each other. On the basis of three diameters (60, 90 and 120cm) of 6, 9 or 12 shades each, every pendant can be installed individually (with a single ring), or forming a double group (two rings) or triple (three), or groups of more.

Combined rings can have the same diameter, or mix sizes. Moreover, the shades can be placed facing up or down as required by the interior design.

As for the steel cables, they can all hang from the canopy or be installed vertically from the ceiling, in which case the canopy is placed independently. Thus, Tribeca Chandelier is a collection made up of an infinite number of combinations starting from only 3 structures.

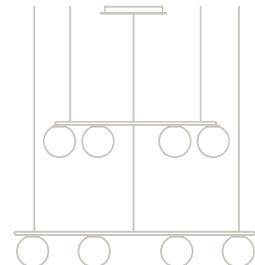
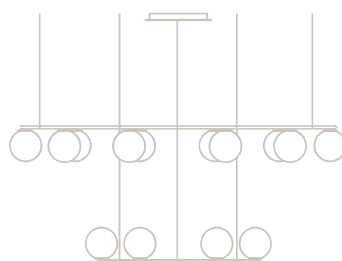

Tribeca Chandelier es una colección de grandes suspensiones combinables entre sí. Partiendo de tres diámetros (60, 90 y 120cm) de 6, 9 o 12 pantallas cada uno, cada colgante se puede instalar individualmente (con un solo aro), o formando un grupo doble (dos aros) o triple (tres)... o de más.

Estos aros pueden ser iguales, o bien de diámetros diferentes. Así mismo, las pantallas se pueden situar mirando hacia arriba o hacia abajo según lo requiera el interiorismo.

Los cables de acero pueden colgar todos del florón, o bien verticalmente desde el techo, en cuyo caso el florón se sitúa de modo independiente. Así, Tribeca Chandelier es una colección formada por una infinidad de combinaciones partiendo tan solo de 3 estructuras.





Tribeca Chandelier

Design by Jordi LLopis

Pantalla alabastro
Shade alabaster

Estructura hierro pintado negro texturizado
Structure black textured painted iron

Led integrado
Integrated Led

No regulable **Not dimmable**
5800/068
5800/098
5800/128

Regulable mediante Triac **Dimmable by Triac**
5800/068RG
5800/098RG
5800/128RG

LED Seoul 4.5W 270lm 2700K CRI>80

CE  

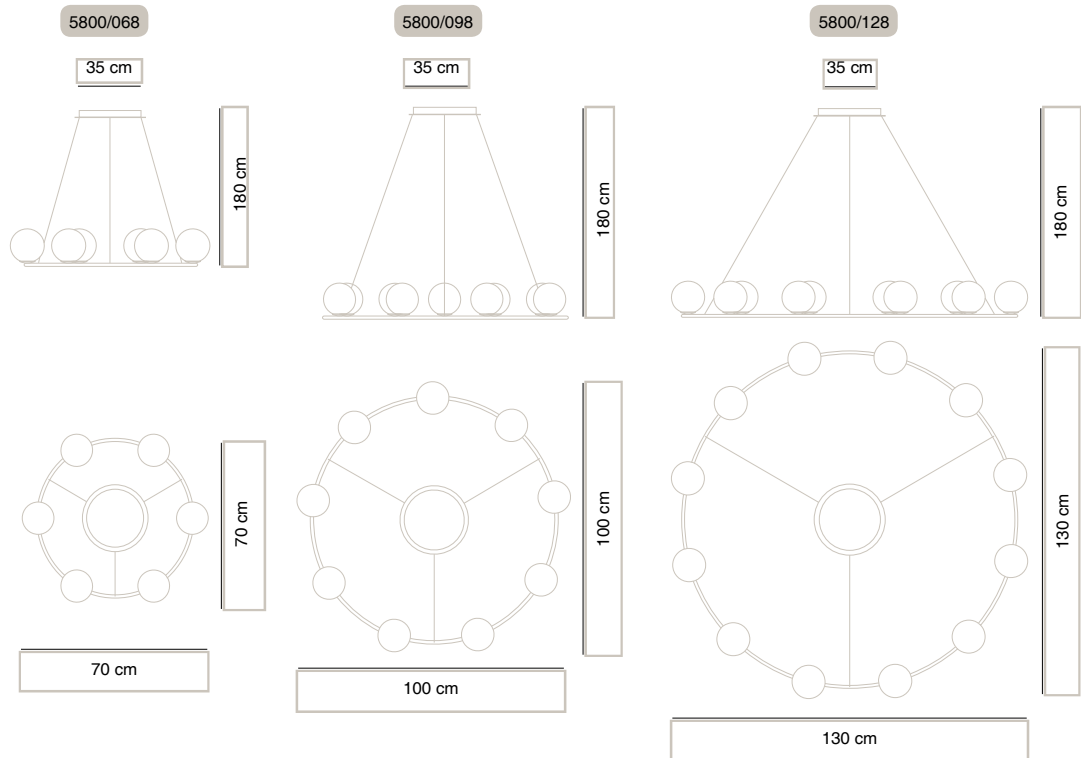







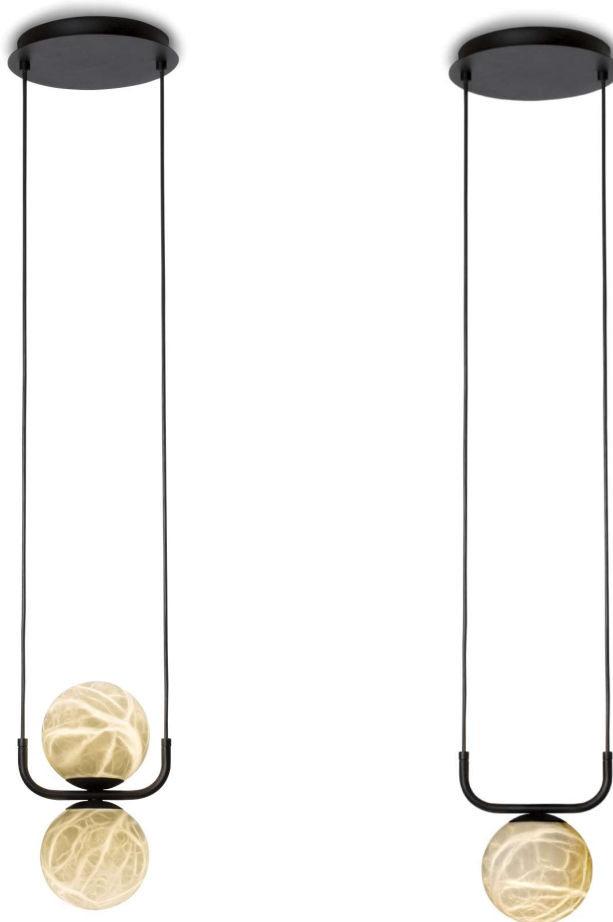

Tribeca

Design by Jordi LLopis

Pantalla alabastro
Shade alabaster

Estructura hierro pintado negro texturizado
Structure black textured painted iron

Led integrado
Integrated Led

No regulable **Not dimmable**
5800/018
5800/028

Regulable mediante Triac **Dimmable by Triac**
5800/018RG
5800/028RG

LED Seoul 4.5W 270lm 2700K CRI>80

CE IP20

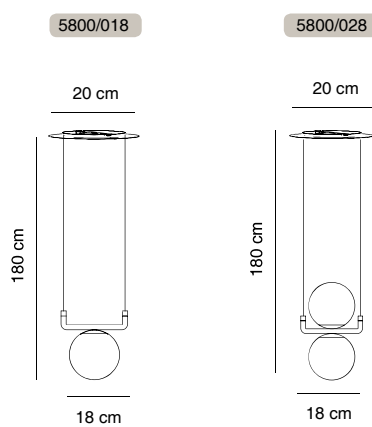



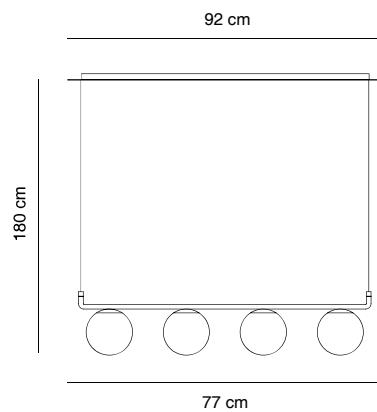
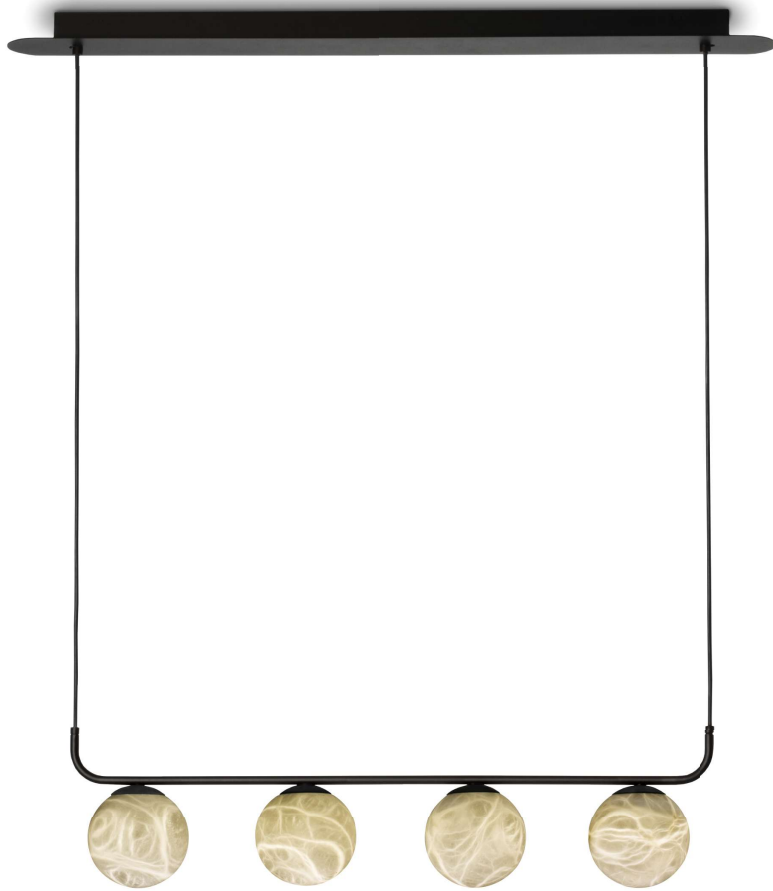

Tribeca

Design by Jordi LLopis

Pantalla alabastro
Shade alabaster

Estructura hierro pintado negro texturizado
Structure textured black painted iron

Led integrado
Integrated Led

No regulable **Not dimmable**
5800/048

Regulable mediante Triac **Dimmable by Triac**
5800/048RG

4 x LED Seoul 4,5W 270lm 2700K CRI>80

CE IP 20









Fuji

Design by Jordi LLopis

Pantalla alabastro
Shade alabaster

Estructura hierro baño electrolítico latón pulido brillo
Structure iron with electrolytic bath in polished brass finish

Lámpara incluida y no reemplazable
Lamp included and not replaceable

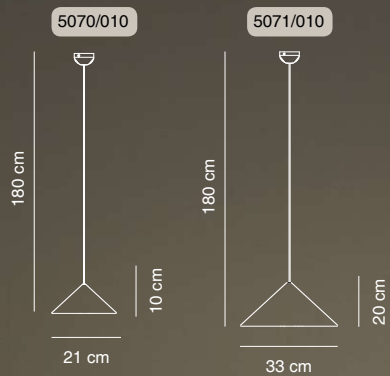

5070/010 no regulable **not dimmable**
LED Seoul 4,6W 2700K 260lm CRI>80

5071/010 no regulable **not dimmable**
LED 4,85W 2700K 335lm CRI>80

5070/010RG regulable mediante Triac **dimmable by Triac**
LED Seoul 4,6W 2700K 260lm CRI>80

5071/010RG regulable mediante Triac **dimmable by Triac**
LED 4,85W 335lm 2700K CRI>80

CE IP 20



Paros Alabaster

Design by Josep Novell & Ernest Perera

Pantalla alabastro
Shade alabaster

Estructura hierro pintado blanco texturizado
Structure textured white painted iron

Lámpara no incluida
Lamp not included

5270/011

 E14 LED

CE  

12 cm

120 cm



19 cm

10 cm



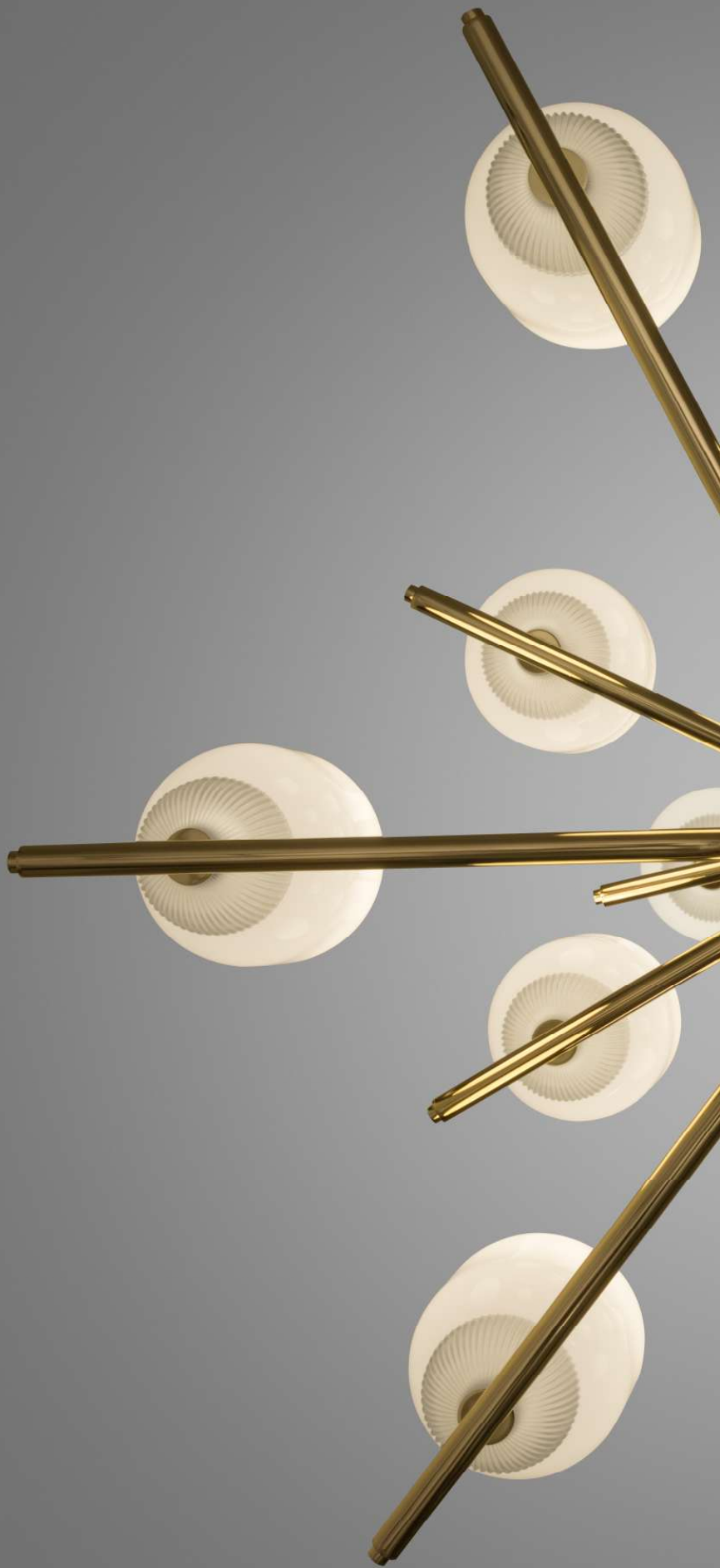









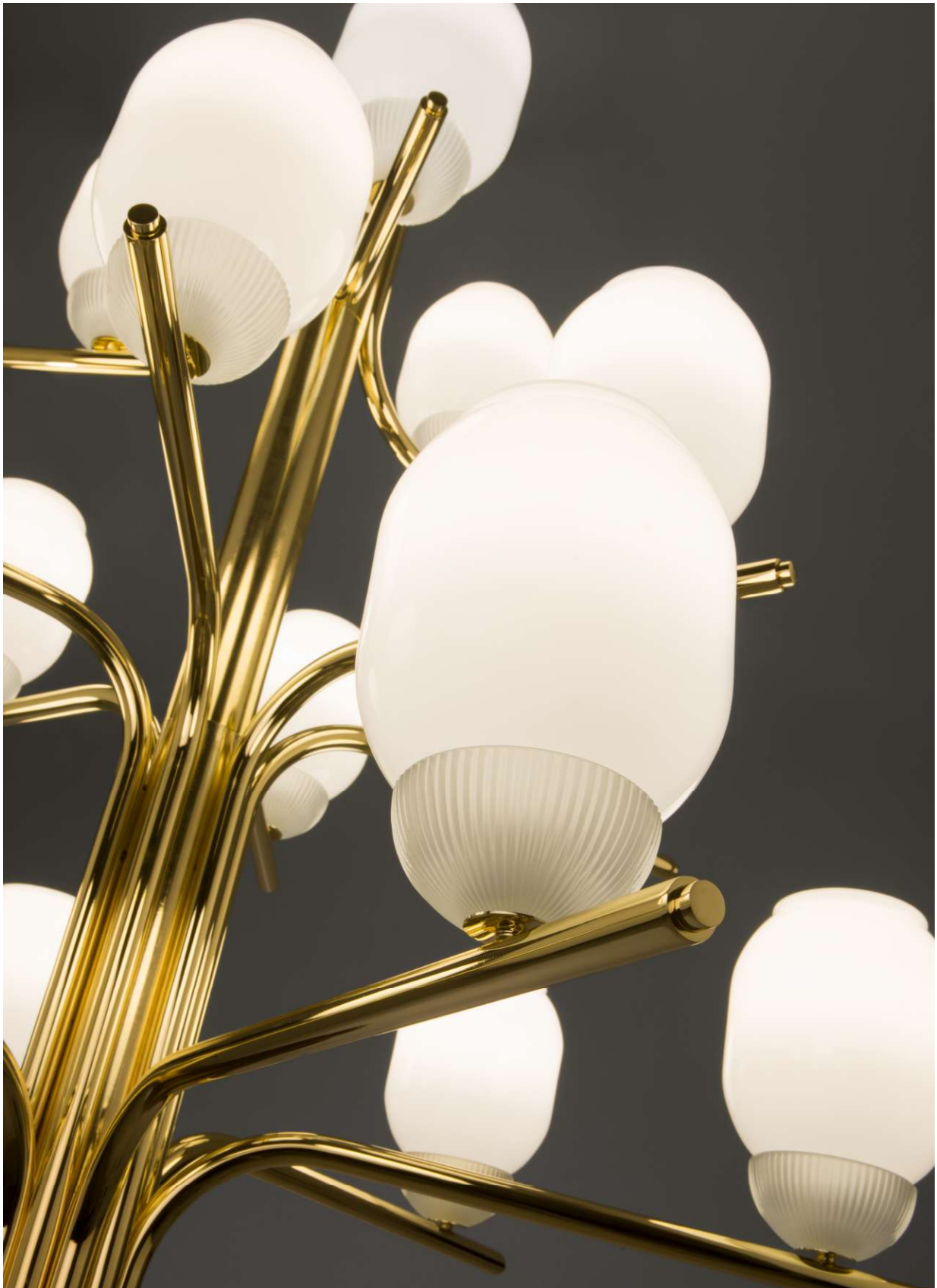











TheChandelier

Design by Alfonso de la Fuente (Pichiglas Studio)

Pantalla cristal opal
Shade opal glass

Estructura hierro
Structure iron

Lámparas no incluidas **Lamps not included**

5170/031 colgante 3 brazos blanco texturizado **pendant 3 arms textured white**
5170/038 colgante 3 brazos negro texturizado **pendant 3 arms textured black**
5170/030 colgante 3 brazos latón pulido brillo **pendant 3 arms polished brass**

5170/091 colgante 9 brazos blanco texturizado **pendant 9 arms textured white**
5170/098 colgante 9 brazos negro texturizado **pendant 9 arms textured black**
5170/090 colgante 9 brazos latón pulido brillo **pendant 9 arms polished brass**

5170/151 colgante 15 brazos blanco texturizado **pendant 15 arms textured white**
5170/158 colgante 15 brazos negro texturizado **pendant 15 arms textured black**
5170/150 colgante 15 brazos latón pulido brillo **pendant 15 arms polished brass**

 E27 LED

CE   IP 20

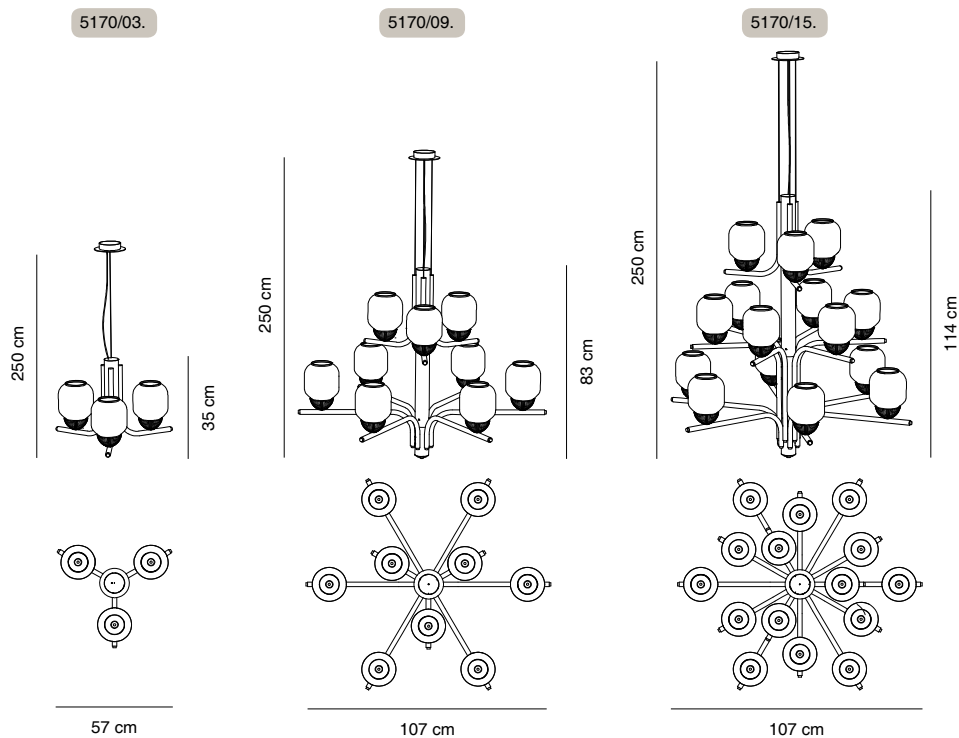









ThePalm

Design by Cristian Cubiñá

Pantalla metacrilato arenado
Shade sandblasted methacrylate

Estructura hierro
Structure iron

No regulable. Versión regulable: consultar
Not dimmable. Dimmable version: please contact us

Led integrado. Integrated Led

5190/121 22,9W 1889lm blanco texturizado *textured white*
5190/128 22,9W 1889lm negro texturizado *textured black*
5190/126 22,9W 1889lm níquel satinado *satin nickel*
5190/120 22,9W 1889lm dorado satinado *satin gold*

5190/181 34,34W 2834lm blanco texturizado *textured white*
5190/188 34,34W 2834lm negro texturizado *textured black*
5190/186 34,34W 2834lm níquel satinado *satin nickel*
5190/180 34,34W 2834lm dorado satinado *satin gold*

5190/301 57,24W 4723lm blanco texturizado *textured white*
5190/308 57,24W 4723lm negro texturizado *textured black*
5190/306 57,24W 4723lm níquel satinado *satin nickel*
5190/300 57,24W 4723lm dorado satinado *satin gold*

LED Seoul 1,9W 248lm 2700K CRI>80

CE IP 20

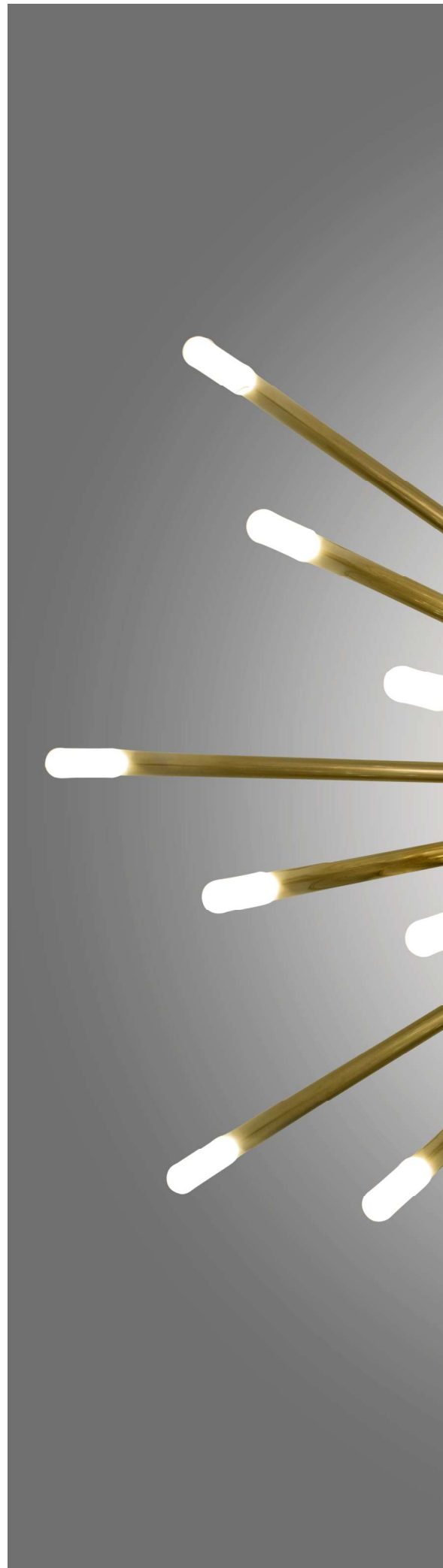
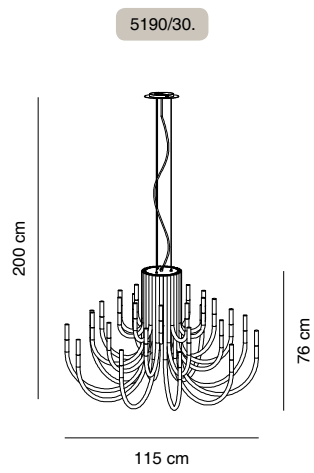
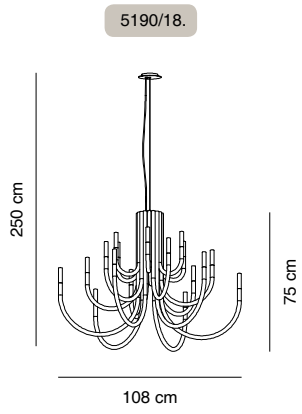
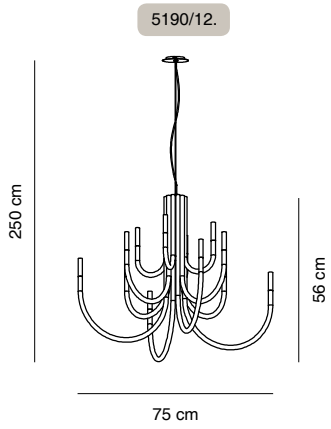

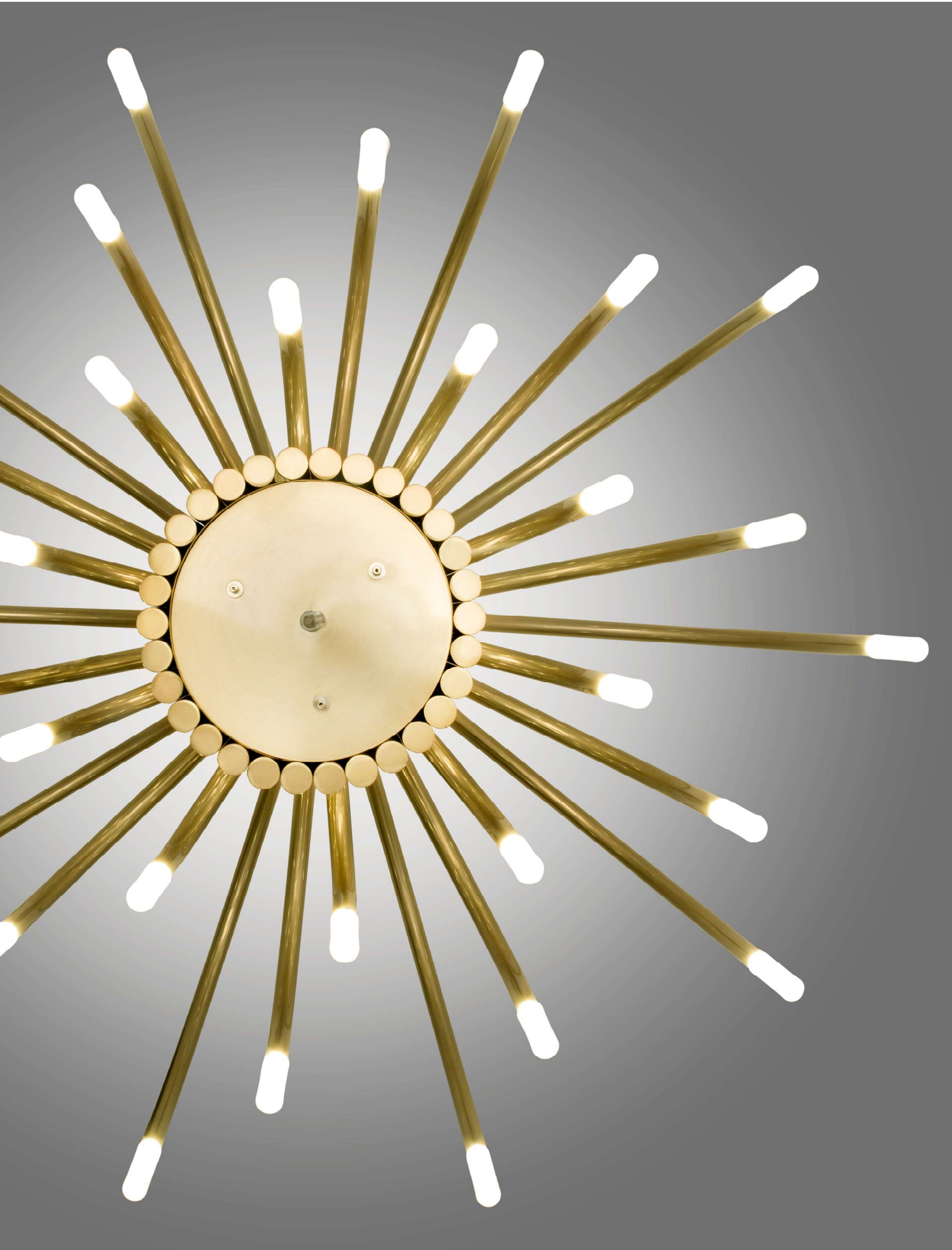







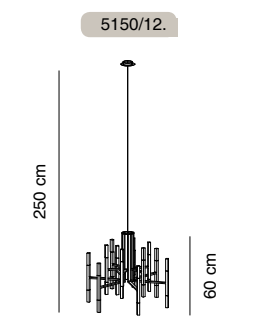
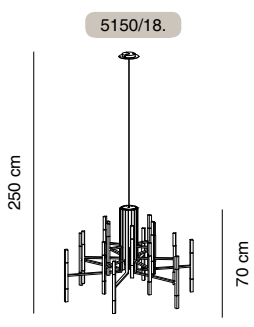
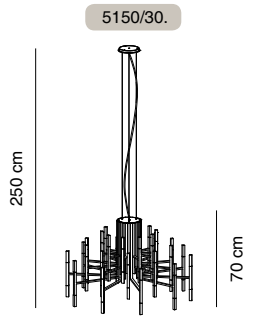



TheLight

Design by Cristian Cubiñá

Estructura hierro
Structure iron

Pantalla metacrilato arenado
Shade sandblasted methacrylate

No regulable. Versión regulable: consultar
Not dimmable. Dimmable version: please contact us

Led integrado. **Integrated Led**

5150/121 44,40W 2498lm blanco texturizado **textured white**
5150/128 44,40W 2498lm negro texturizado **textured black**
5150/126 44,40W 2498lm níquel satinado **satin nickel**
5150/120 44,40W 2498lm dorado satinado **satin gold**

5150/181 66,60W 3748lm blanco texturizado **textured white**
5150/188 66,60W 3748lm negro texturizado **textured black**
5150/186 66,60W 3748lm níquel satinado **satin nickel**
5150/180 66,60W 3748lm dorado satinado **satin gold**

5150/301 111,00W 6245lm blanco texturizado **textured white**
5150/301 111,00W 6245lm negro texturizado **textured black**
5150/306 111,00W 6245lm níquel satinado **satin nickel**
5150/300 W 6245lm dorado satinado **satin gold**

LED Seoul 1,9W 248lm 2700K CRI>80

CE IP 20







Moon

Design by Josep Novell & Ernest Perera

Pantalla polietileno rotomoldeado opal
Shade white textured rotomoulded polyethylene

Estructura hierro pintado blanco texturizado
Structure iron textured white painted

No regulable
Not dimmable

Led integrado
Integrated Led

5850/011

LED Epistar 40W 3250lm 3000K CRI>80

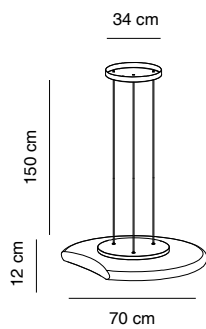

CE IP 23 





SuperMoon

Design by Josep Novell & Ernest Perera

Pantalla polietileno rotomoldeado opal
Shade white textured rotomoulded polyethylene

Estructura hierro pintado blanco texturizado
Structure iron textured white painted

No regulable
Not dimmable

Led integrado
Integrated Led

5860/041

4 x LED Epistar 40W 3250lm 3000K CRI>80

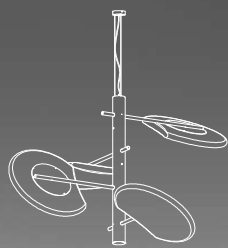

180 cm

200 cm

CE   



Deco

Design by Cristian Cubiñá

Pantalla cristal prensado de Bohemia en acabado transparente

Shade pressed Bohemia crystal transparent glass

Estructura hierro

Structure iron

Lámpara no incluida

Lamp not included

5550/011 cromo **chrome**

5530/011 dorado brillo **polished gold**

 G9 LED

CE  

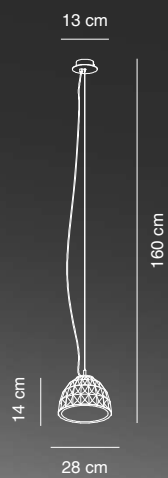







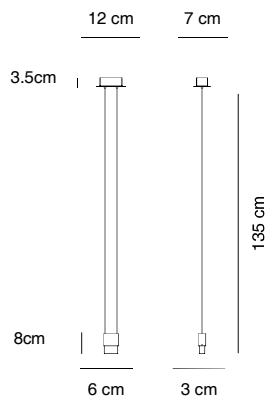

Led Box

Design by Cristian Cubiñá

Pantalla fundición aluminio pulido
Shade polished die cast aluminium

Cristal transparente arenado
Transparent sandblasted glass

Estructura de acero inoxidable pulido espejo
Structure mirror polished stainless steel

No regulable
Not dimmable

Led integrado
Integrated Led

5080/016

LED Citizen 3W 250lm 2700K

CE IP 20







Led Oval

Design by Cristian Cubiñá

Pantalla fundición aluminio pulido
Shade polished die cast aluminium

Estructura acero inoxidable pulido espejo
Structure mirror polished stainless steel

No regulable
Not dimmable

Led integrado
Integrated Led

5180/017 colgante individual **single pendant**

5180/047 colgante lineal 4 luces **linear pendant 4 lights**

LED Citizen 3W 250lm 2700K

CE IP 20

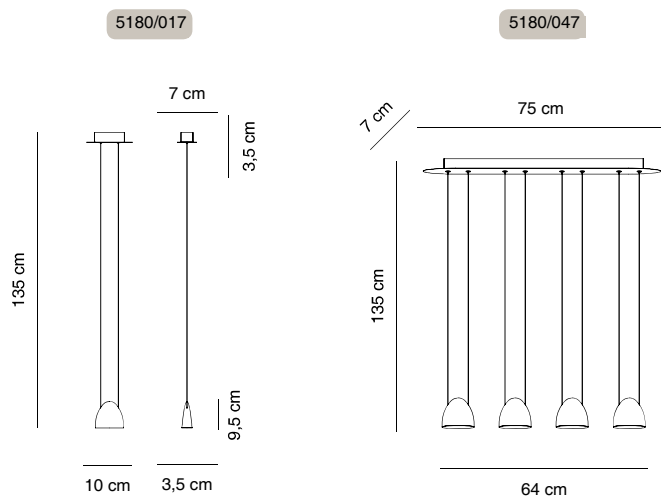
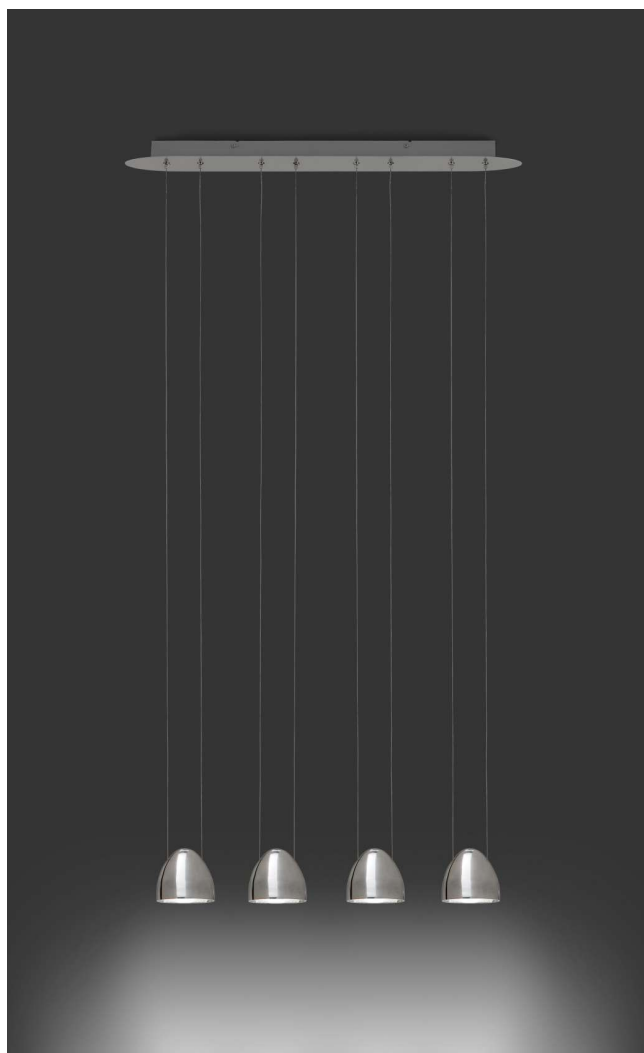







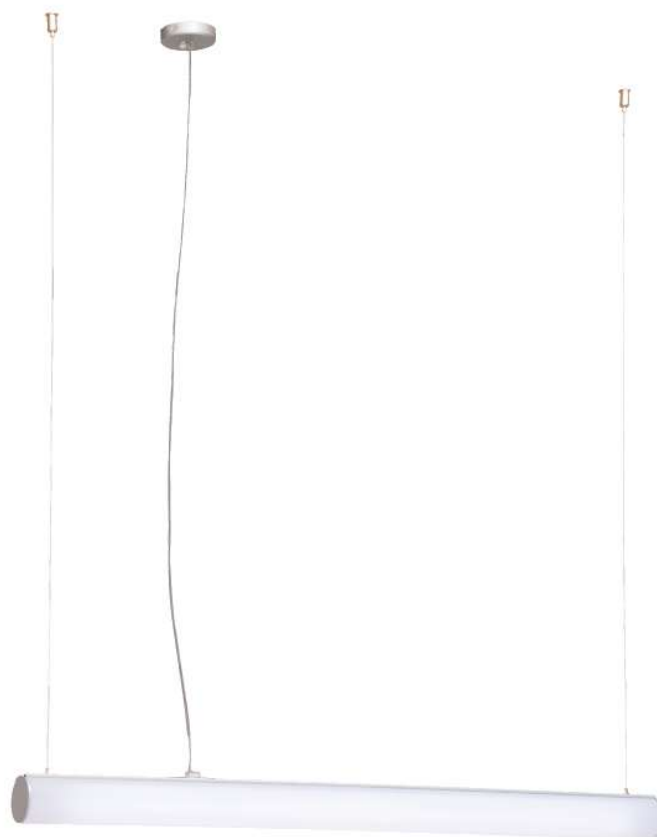

Bath A Led

Design by Oriol LLahona

Pantalla policarbonato opal
Shade opal polycarbonate

Estructura hierro pintado epoxy
Structure epoxy painted iron

Regulable mediante Triac
Dimmable by Triac

Led integrado
Lamp included

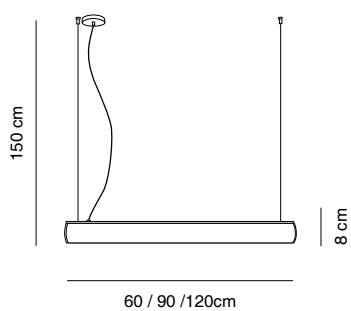

5420/061LED 60cm 14W 1350lm blanco texturizado **textured white**
5420/091LED 90cm 22W 2160lm blanco texturizado **textured white**
5420/121LED 120cm 30,8W 2970lm blanco texturizado **textured white**

5420/066LED 60cm 14W 1350lm plata **silver**
5420/096LED 90cm 22W 2160lm plata **silver**
5420/126LED 120cm 30,8W 2970lm plata **silver**

Led 230V 2700K

CE IP 23









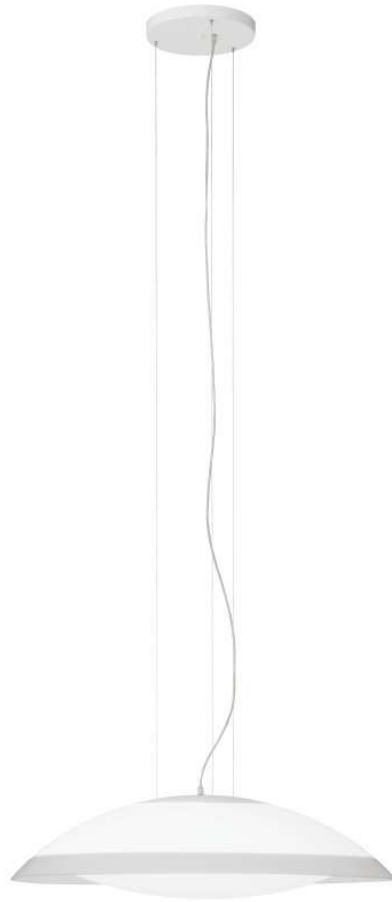

Lens Led

Design by Cristian Cubiná

Pantalla metacrilato opal
Shade opal methacrylate

Estructura hierro pintado epoxy blanco texturizado
Structure iron epoxy textured white painted

No Regulable
Not dimmable

Led integrado
Integrated Led

5290/011

LED Epistar 40W 3250lm 3000K CRI>80

CE IP 20

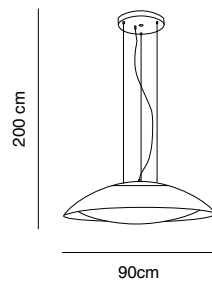

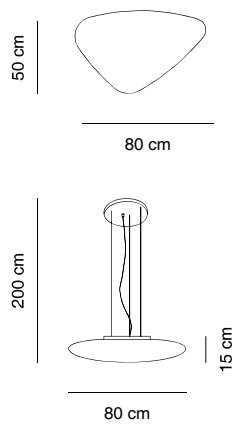

Stone Led

Design by Josep Puig & Josep Novell

Pantalla polietileno rotomoldeado
Shade rotomoulded polyethylene

Estructura hierro pintado epoxy blanco texturizado
Structure epoxy textured white painted iron

No Regulable
Not dimmable

Led integrado
Integrated Led

5300/036

LED Epistar 40W 3250lm 3000K CRI>80

CE IP 20 



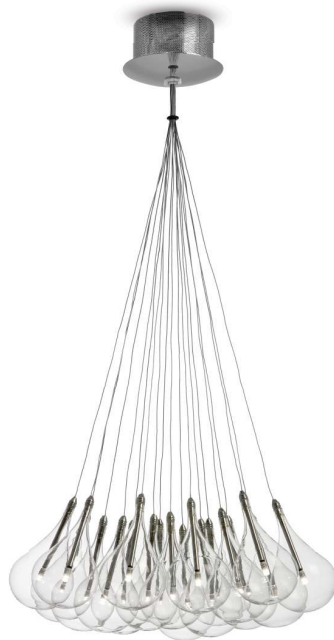

Al subir y bajar el aro de silicona conseguimos variar la forma de luminaria



By pulling up or down the silicon ring we can modify the external outfit of the luminaire.

5110/196

16 cm

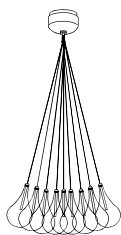

∅ 60 cm

5110/376

20 cm

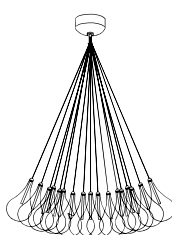

∅ 80 cm

Drop Led

Design by Cristian Cubiñá

Pantalla cristal borosilicato transparente
Shade borosilicate transparent glass

Estructura hierro cromado
Structure chrome iron

Los cables pueden acortarse máx 60cm
Cables can be shortened max 60cm

Lámparas Led incluidas, reemplazables, no regulables
Led lamps included, replaceable, not dimmable

Estructura normal largo max.170 - min.110cm

Normal structure length max.170 - min.110cm

5110/196LED G4 19 x 1,1W 95lm 2700K CRI>80

5110/376LED G4 37 x 1,1W 95lm 2700K CRI>80

Estructura especial largo 70cm

Special structure length 70cm

5110/196S LED G4 19 x 1,1W 95lm 2700K CRI>80

5110/376S LED G4 37 x 1,1W 95lm 2700K CRI>80

CE   IP 20







5112/246

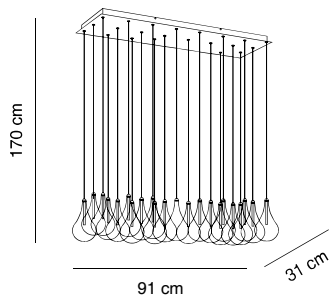

5113/166

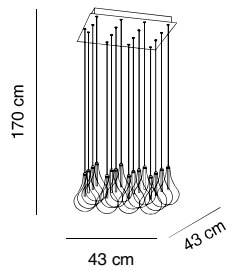

Drop Led

Design by Cristian Cubiñá

Pantalla cristal borosilicato transparente
Shade borosilicate transparent glass

Estructura hierro y acero inoxidable pulido espejo
Structure iron and mirror polished stainless steel

Lámparas Led incluidas, reemplazables, no regulables
Led lamps included, replaceable, not dimmable

5112/246LED G4 24x1,1W 95lm 2700K CRI>80
 5113/166LED G4 16x1,1W 95lm 2700K CRI>80

CE IP20



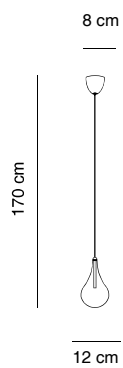
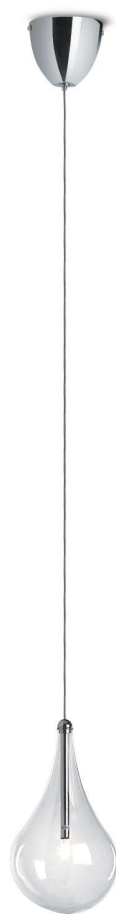

Drop Led

Design by Cristian Cubiñá

Pantalla cristal borosilicato transparente
Shade borosilicate transparent glass

Estructura hierro cromado
Structure chromed iron

Lámpara Led incluida, reemplazable, no regulable
Led lamp included, replaceable, not dimmable

5111/016LED

 G4 Led 1,1W 95lm 2700K CRI>80

€  

Plafones Ceiling Lamps

Bath A Led / Deco / Drop S Led / Drop Downlight / Lens / Mizu / Moon / Stone /
SuperMoon / Tribeca







Tribeca Downlight

Design Jordi LLopis

Pantalla alabastro
Shade alabaster

Estructura hierro pintado negro texturizado
Structure black textured painted iron

Driver incluido **Driver included**

Led integrado
Integrated led

No regulable **Not dimmable**
9800/018

Regulable mediante Triac **Dimmable by Triac**
9800/018RG

LED Seoul 4,5W 270lm 2700K CRI>80

CE IP 20 

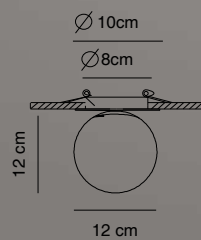







Drop S Led

Design by Cristian Cubiñá

5110/196S

16 cm

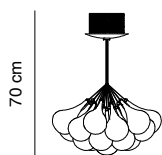

Ø 70 cm

5110/376S

20 cm

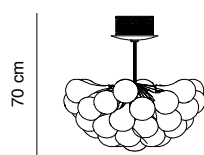

Ø 80 cm

Pantalla cristal borosilicato transparente
Shade borosilicate transparent glass

Estructura hierro cromado **Structure chromed iron**

Lámparas Led incluidas, reemplazables, no regulables
Led lamps included, replaceable, not dimmable

5110/196S LED 19 x G4 1,1W 95lm 2700K CRI>80
5110/376S LED 37 x G4 1,1W 95lm 2700K CRI>80

CE IP 20



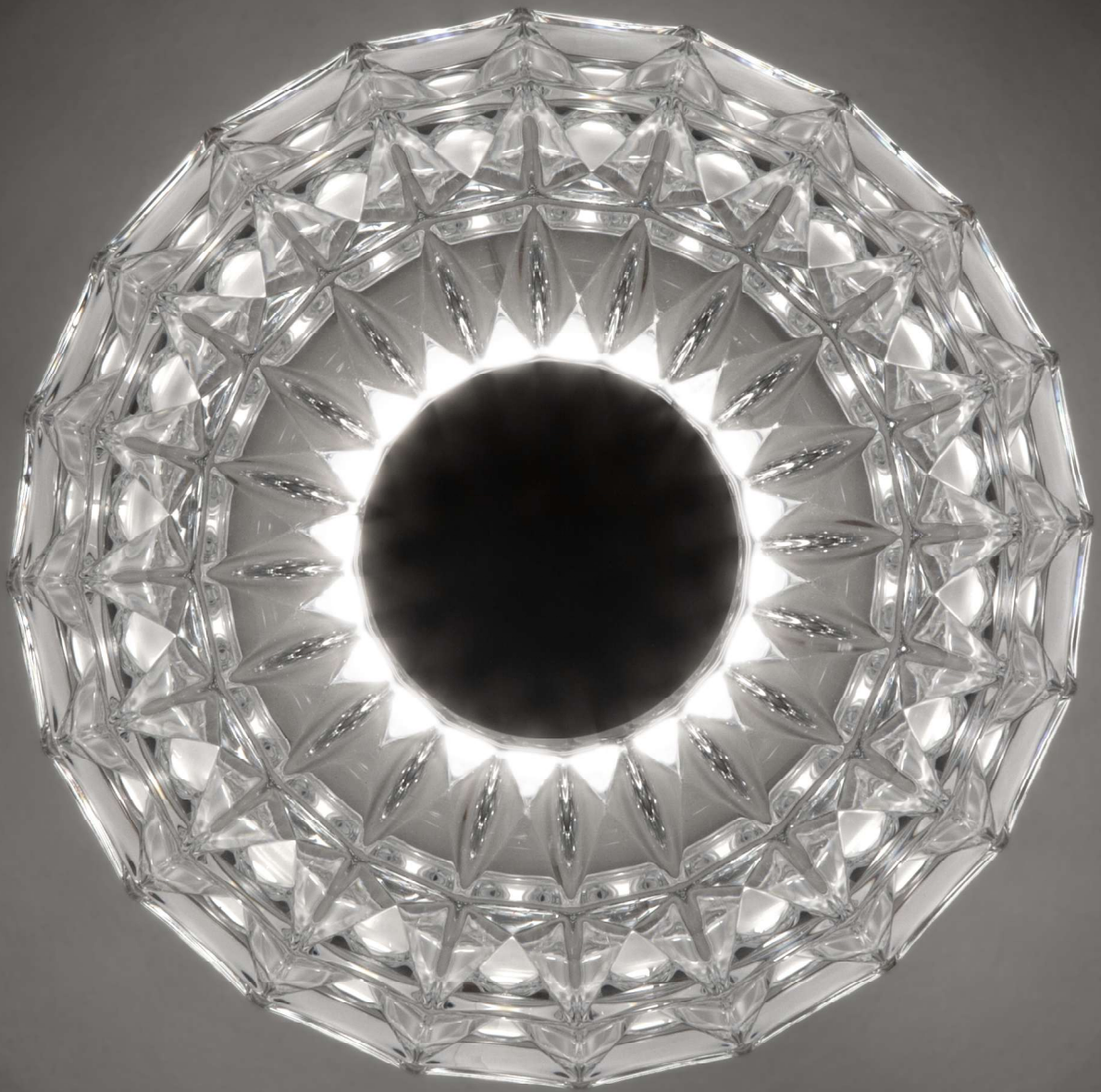



Deco

Design by Cristian Cubiñá

Pantalla cristal prensado de Bohemia en acabado transparente
Shade pressed Bohemia crystal transparent glass

Estructura hierro
Structure iron

Lámpara no incluida *Lamp not included*

9550/011 cromo *chrome*

9530/011 dorado brillo polished *gold*

 E14 LED

CE   IP 20

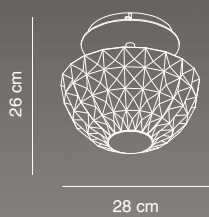







Moon

Design by Josep Novell & Ernest Perera

Pantalla polietileno rotomoldeado texturizado
Shade rotomoulded polyethylene textured

Estructura hierro pintado blanco texturizado
Structure iron painted textured white

No regulable
Not dimmable

Led integrado
Integrated Led



9850/011

LED Epistar 40W 3250lm 3000K CRI>80

CE   





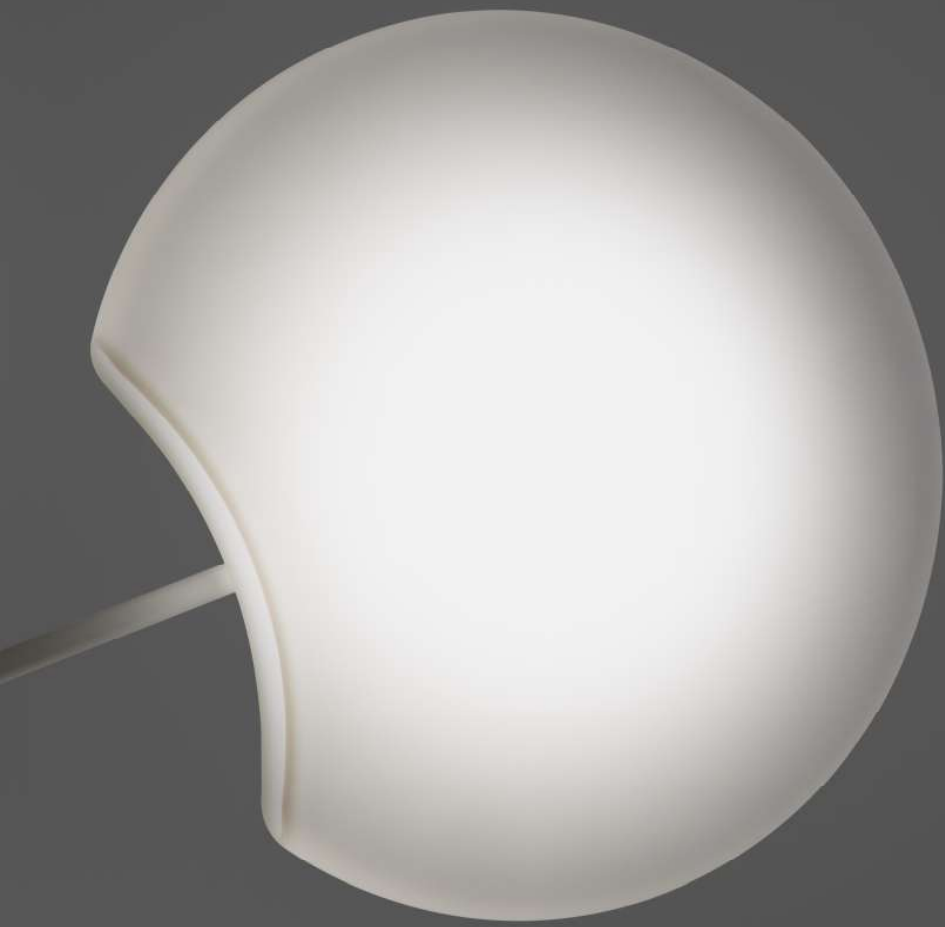

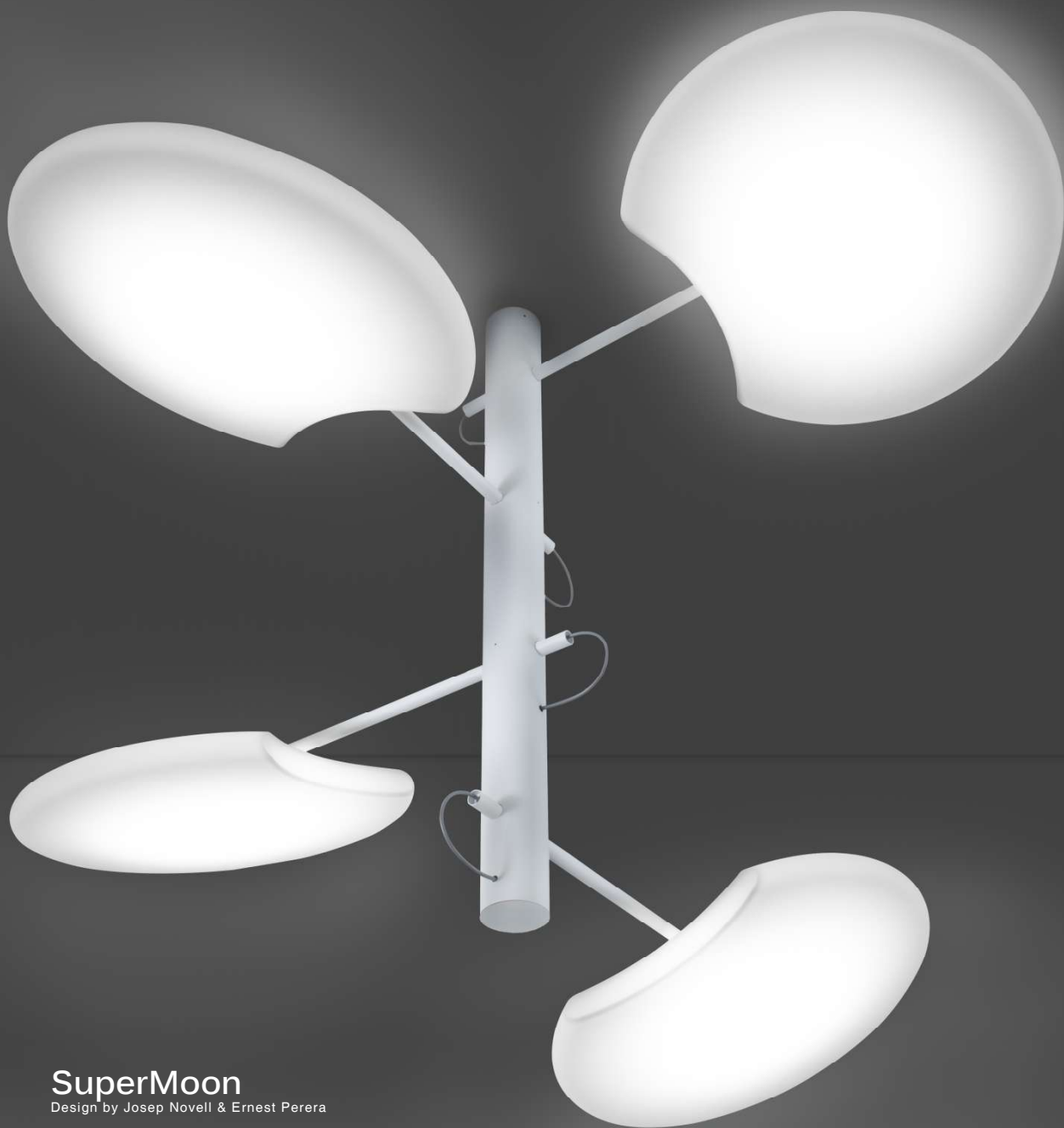

SuperMoon

Design by Josep Novell & Ernest Perera

Pantalla polietileno rotomoldeado texturizado
Shade rotomoulded polyethylene textured

Estructura hierro pintado blanco texturizado
Structure iron painted textured white

No regulable
Not dimmable

Led integrado
Integrated Led

9860/041

4 x LED Epistar 40W 3250lm 3000K CRI>80

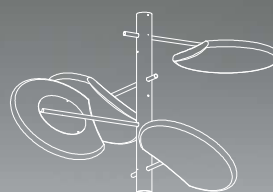

128 cm

200 cm







Stone Led

Design by Josep Novell & Josep Puig

Pantalla polietileno rotomoldeado
Shade rotomoulded polyethylene



Estructura hierro pintado epoxy blanco texturizado
Structure epoxy textured white painted iron

No regulable **Not dimmable**

Led integrado
Integrated Led

9300/036

LED Epistar 40W 3250lm 3000K CRI>80

CE   

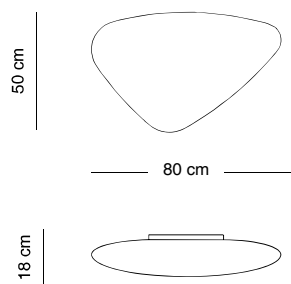



Bath A Led

Design by Oriol LLahona

Pantalla policarbonato opal
Shade opal polycarbonate

Estructura hierro pintado epoxy
Structure epoxy painted iron

Regulable mediante Triac
Dimmable by Triac

Led integrado
Integrated Led

4420/061LED 14W 1350lm 60 cm blanco texturizado **textured white**
4420/091LED 22W 2160lm 90 cm blanco texturizado **textured white**
4420/121LED 30,8W 2970lm 120 cm blanco texturizado **textured white**

4420/066LED 14W 1350lm 60 cm plata **silver**
4420/096LED 22W 2160lm 90 cm plata **silver**
4420/126LED 30,8W 2970lm 120 cm plata **silver**

LED 230V 2700K

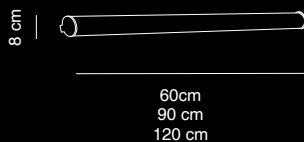

CE IP 23





Mizu

Design by Ricard Ferrer

Pantalla cristal triplex opal mate
Shade matt opal triplex glass

Estructura hierro pintado epoxy
Structure iron epoxy painted

Lámpara no incluida
Lamp not included

9282/011 blanco texturizado **textured white**
9282/016 plata **silver**
9283/011 blanco texturizado **textured white**
9283/016 plata **silver**

9281/011 blanco texturizado **textured white**
9281/016 plata **silver**

 G9 LED

CE  

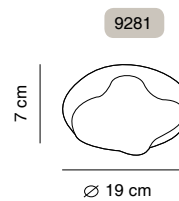
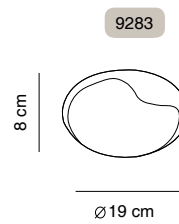
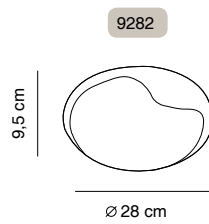









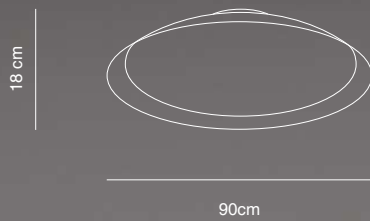

Lens Led

Design by Cristian Cubiná

Pantalla de metacrilato blanco
Shade opal methacrylate

Estructura hierro pintado epoxy blanco texturizado
Structure white epoxy painted iron

No regulable
Not dimmable

Led integrado
Integrated Led

9290/011

LED Epistar 40W 3250lm 3000K CRI>80

CE  



Drop Downlight Led

Design Cristian Cubiñá

Pantalla cristal borosilicato transparente
Shade borosilicate transparent glass

Foco empotrado. Estructura hierro cromado
Embedded downlight. Structure chromed iron

Driver incluido
Driver included

Lámpara incluida, no regulable y reemplazable
Lamp included, not dimmable and replaceable

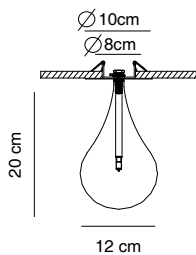

9111/016LED

LED G4 1,1W 95lm 2700K CRI>80

CE IP 20





Apliques

Wall Lamps

Bath A Led / Flat Led / Hotel / Madame / MiniFlat / MiniSpot / Mizu / Paros
Alabaster / Tribeca / Totem II







Totem II

Design by Cristian Cubiñá

Pantalla cristal de borosilicato estriado transparente
Shade transparent fluted borosilicate glass

Estructura hierro pintado texturizado o baño electrolítico
Structure textured painted or electroplated iron

No regulable
Not dimmable

Tira Led integrado
Integrated Led strip

4333/012 25cm 10W bronce satinado **satin bronze**
4333/018 25cm 10W negro texturizado **textured black**

LED 10W 1150lm 2700K CRI>80

4334/012 50cm 20W bronce satinado **satin bronze**
4334/018 50cm 20W negro texturizado **textured black**

LED 20W 2300lm 2700K CRI>80

CE  

4334

4333

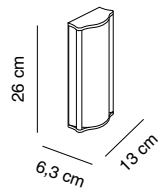
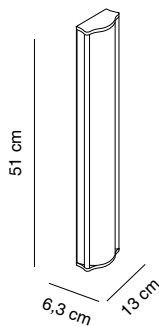











MiniSpot

Design by Cristian Cubiñá

Estructura hierro pintado texturizado
Structure iron textured painted

No Regulable. Incluye interruptor On-Off
Not dimmable. Switch included On-Off

Led integrado **Integrated Led**

4525/011 blanco **white**
4525/018 negro **black**

LED Cree 3W 260lm 3000K CRI>80

CE  

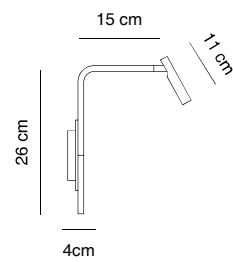







Tribeca

Design by Jordi Llopis

Pantalla alabastro
Shade alabaster

Estructura hierro pintado negro texturizado
Structure textured black painted iron

Interruptor solo para el lector. Lector no regulable
Switch only for the reading light. Reading light not dimmable

Leds integrados
Integrated Leds

No regulable **Not dimmable**
4800/028

Regulable mediante Triac **Dimmable by Triac**
4800/028RG

LED Seoul 4.5W 270lm 2700K CRI>80
LED Cree 3W 260lm 30° 3000K CRI>80

CE IP 20

14 cm

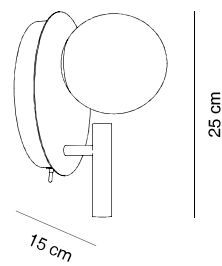

25 cm

15 cm









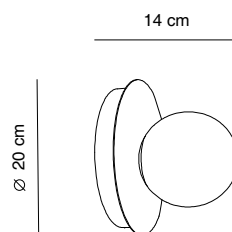

Tribeca

Design by Jordi LLopis

Pantalla alabastro
Shade alabaster

Estructura hierro pintado negro texturizado
Structure black textured epoxy painted iron

No regulable **Not dimmable**

Led integrado
Integrated Led

No regulable **Not dimmable**
4800/018

Regulable mediante Triac **Dimmable by Triac**
4800/018RG

LED Seoul 4.5W 270lm 2700K CRI>80

CE  



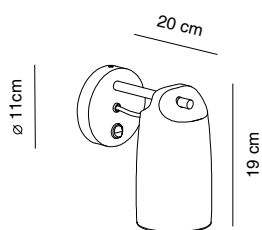

Paros Alabaster

Design by Josep Novell & Ernest Perera

Pantalla alabastro
Shade alabaster

Estructura hierro pintado blanco texturizado
Structure textured white painted iron

Con interruptor **With switch**

Lámpara no incluida, reemplazable
Lamp not included, replaceable

4270/011

 E14 LED

CE  





TheLight

Design by Cristian Cubiñá

Estructura hierro
Structure iron

Pantalla metacrilato arenado
Shade sandblasted methacrylate

No regulable. Versión regulable, consultar
Not dimmable. Dimmable version, please contact us

Led integrado. **Integrated Led**

4150/031 blanco texturizado textured **white**
4150/038 negro texturizado textured **black**
4150/036 níquel satinado **satin nickel**
4150/030 dorado satinado **satin gold**

LED Cree 3 x 1,9W 248lm 2700K CRI>80

CE IP 20

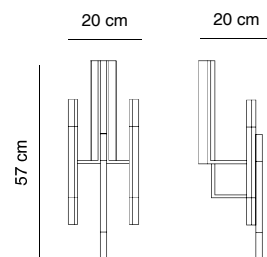

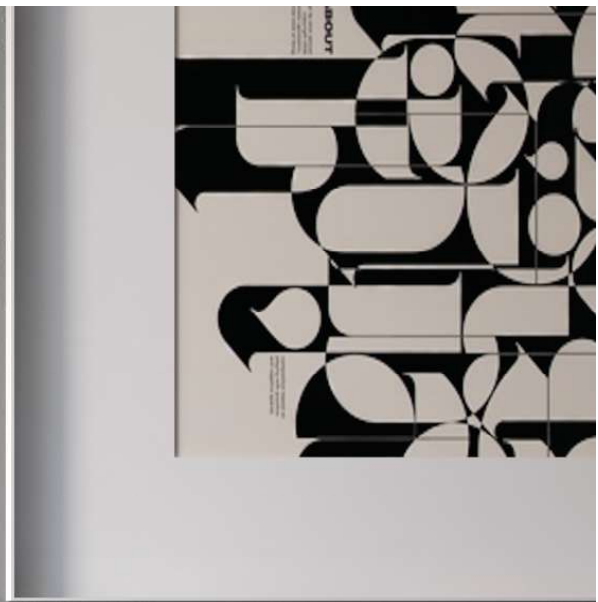

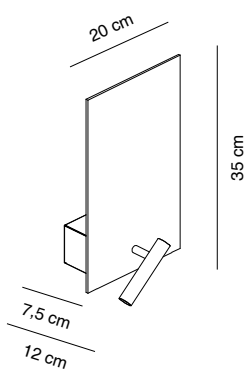

Flat Led

Design by Josep Novell & Ernest Perera

Estructura hierro
Structure iron

Con interruptor solo para el lector o dos interruptores
With switch only for the reading light or two switches

Led integrado en el lector
Integrated Led included for the reading light

Con interruptor solo para el lector
With switch only for the reading light
4416/011 blanco texturizado **textured white**
4416/018 negro texturizado **textured black, one switch**

Con dos interruptores **With two switches**
4416/211 blanco texturizado **textured white**
4416/218 negro texturizado **textured black**

E27 LED

LED Cree 3W 260lm 30° 3000K CRI>80

CE IP 20





276 / Alma Light

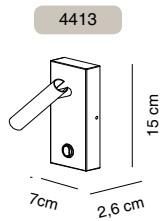
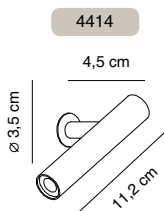
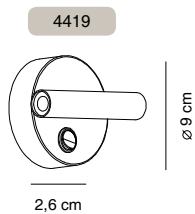

MiniFlat

Design by Cristian Cubiñá

Estructura hierro
Structure iron

No regulable
Not dimmable

Led integrado
Integrated Led

4419/011 blanco texturizado **textured white**
4419/018 negro texturizado **textured black**
4419/016 níquel satinado **satín nickel**

4413/011 blanco texturizado **textured white**
4413/018 negro texturizado **textured black**
4413/016 níquel satinado **satín nickel**

4414/011 blanco texturizado **textured white**
4414/018 negro texturizado **textured black**
4414/016 níquel satinado **satín nickel**

LED Cree 3W 260lm 30° 3000K CRI>80

CE IP 20



Hotel

Design by Cristian Cubiñá

Pantalla algodón negra
Shade black cotton

Estructura hierro pintado epoxy champagne
Structure epoxy champagne painted iron

Con interruptor para el lector
With switch for the reading light

Led integrado
Integrated Led

4540/018

 E27 LED

LED 3W 30° 4000K

CE 

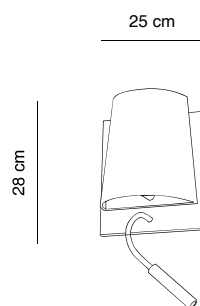







60cm
90cm
120 cm



Bath A Led

Design by Oriol LLahona

Pantalla policarbonato opal
Shade opal polycarbonate

Estructura hierro pintado epoxy
Structure epoxy painted iron

Regulable mediante Triac
Dimmable by Triac

Led integrado
Integrated Led

4420/061LED 14W 1350lm 60cm blanco texturizado **textured white**
4420/091LED 22W 2160lm 90cm blanco texturizado **textured white**
4420/121LED 30,8W 2970lm 120cm blanco texturizado **textured white**

4420/066LED 14W 1350lm 60cm plata **silver**
4420/096LED 22W 2160lm 90cm plata **silver**
4420/126LED 30,8W 2970lm 120cm plata **silver**

LED 230V 2700K

CE  



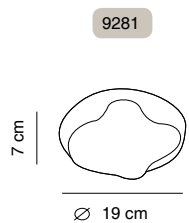
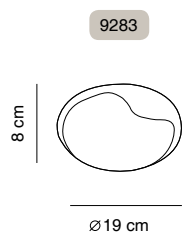
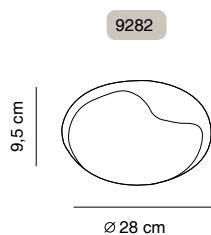

Mizu

Design by Ricard Ferrer

Pantalla cristal triplex opal mate
Shade matt opal triplex glass

Estructura hierro pintado epoxy
Structure iron epoxy painted

Lámpara no incluida
Lamp not included

9282/011 blanco texturizado **textured white**
9282/016 plata **silver**
9283/011 blanco texturizado **textured white**
9283/016 plata **silver**

9281/011 blanco texturizado **textured white**
9281/016 plata **silver**

 G9 LED

CE  





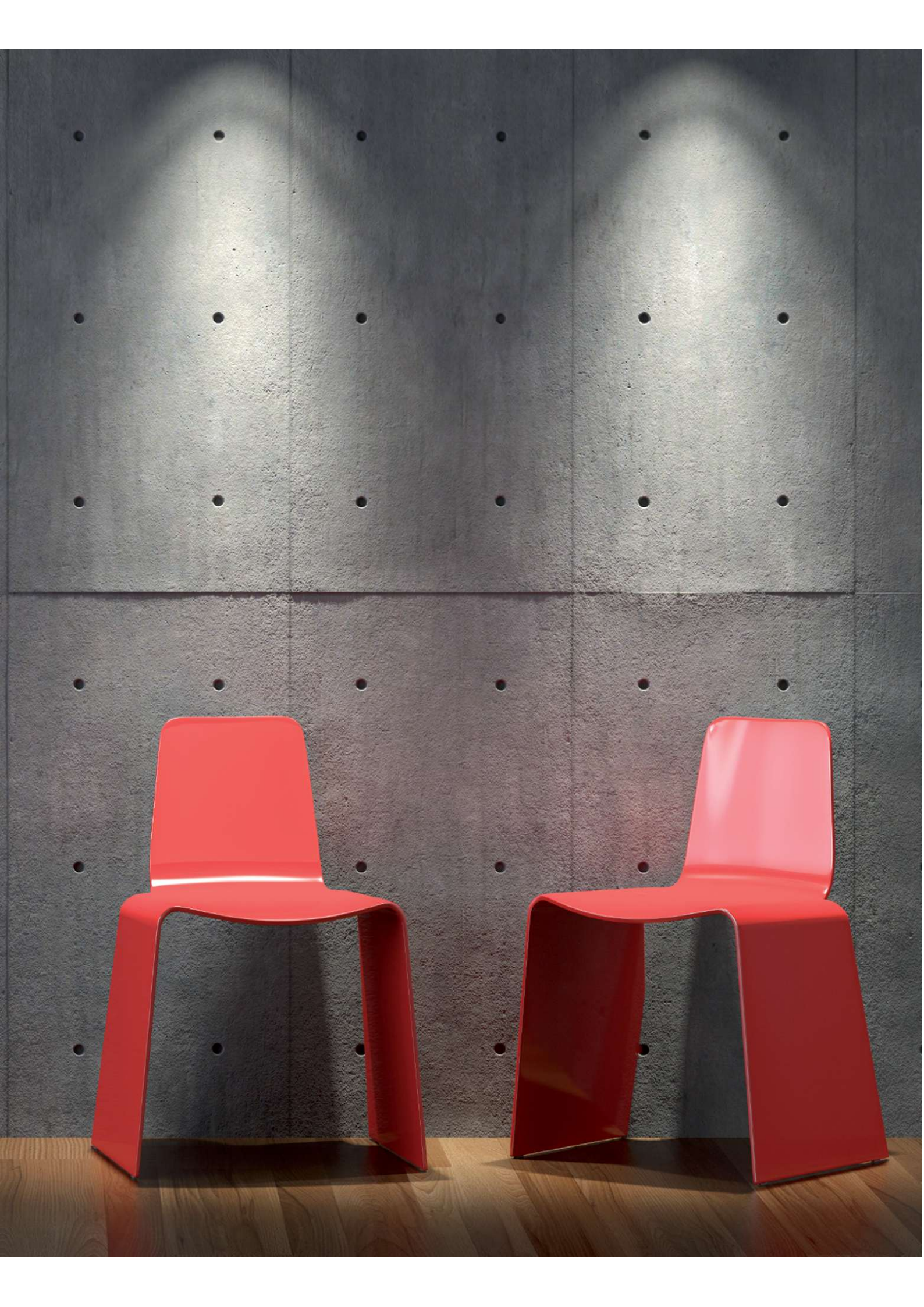





4650/016 4650/018



12,5 cm

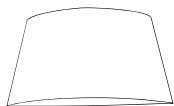

24,5 cm

Madame

Design by Oriol LLahona

Estructura hierro pintado
Structure iron painted

Con interruptor
With switch

Lámpara no incluida
Lamp not included

4650/016 blanco texturizado plata interior **textured white silver inside**
4650/018 negro texturizado dorado interior **textured black gold inside**

 G9 LED

CE   IP 20

Exterior Outdoor

Stone Out Led / Tiny





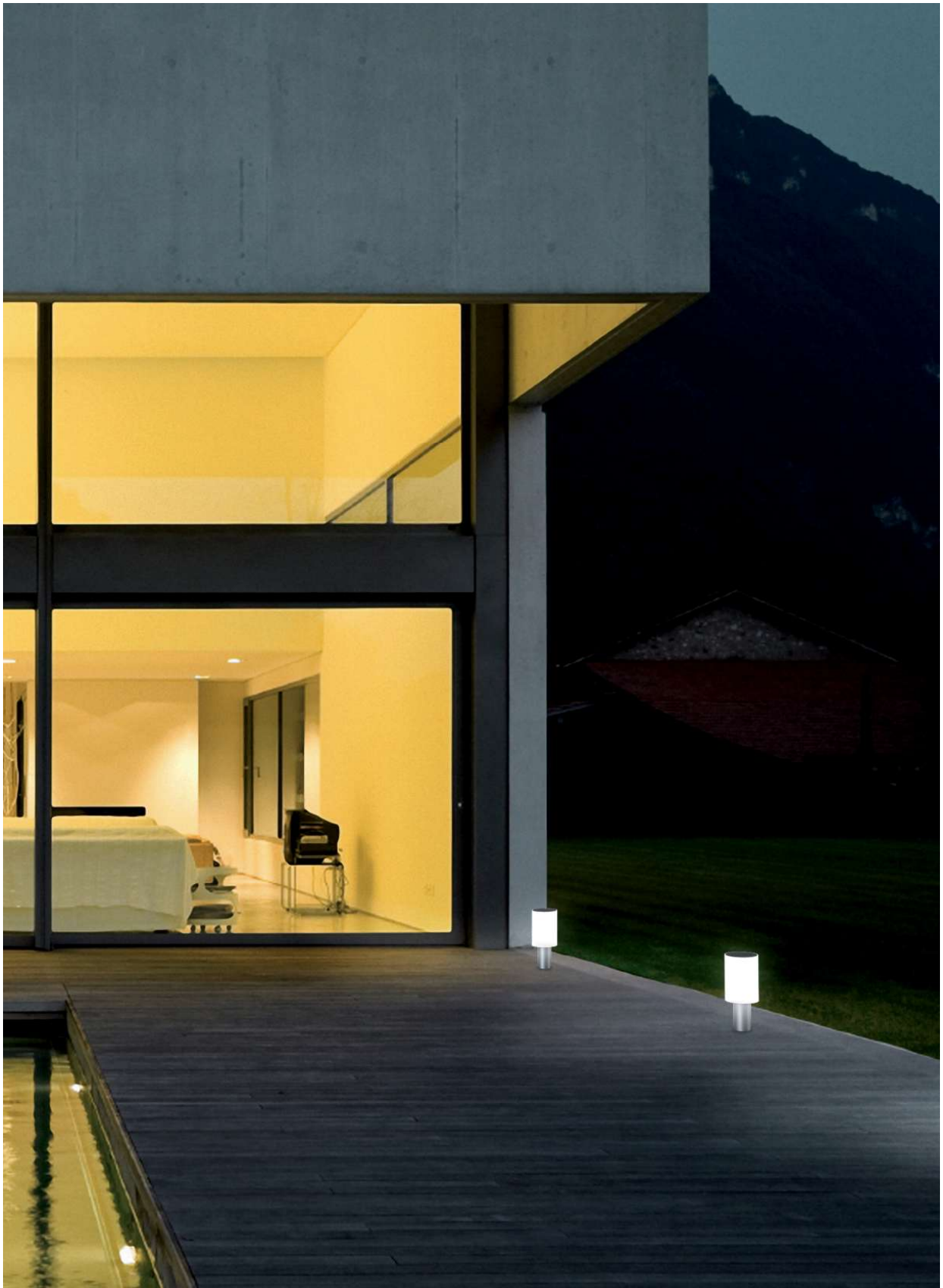



Tiny

Design by Josep Novell & Josep Puig

Estructura latón acabado níquel satinado
Structure brass satin nickel finish

Pantalla polietileno rotomoldeado Lámpara no incluida
Shade rotomoulded polyethylene Lamp not included

4370/016
4371/016
4372/016

 E27 LED

CE   

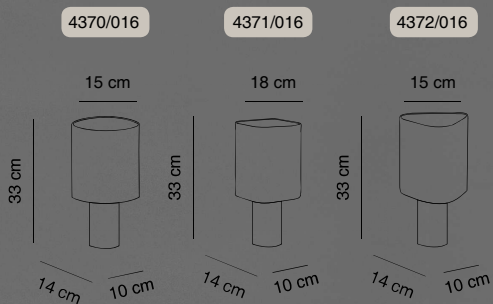

Tiny

Design by Josep Novell & Josep Puig

Estructura latón acabado níquel satinado
Structure brass satin nickel finish

Pantalla polietileno rotomoldeado Lámpara no incluida
Shade rotomoulded polyethylene Lamp not included

2370/016
2371/016
2372/016

 E27 LED

CE   

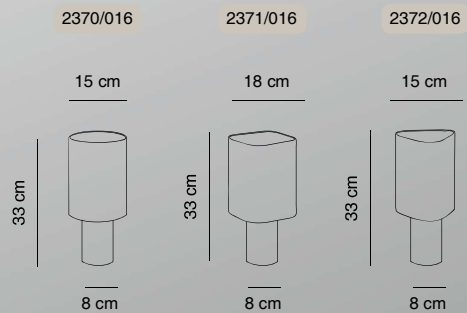

Tiny

Design by Josep Novell & Josep Puig

Estructura latón acabado níquel satinado
Structure brass satin nickel finished

Con 4mt cable con funda de neopreno y clavija Schuko
With 4mt neoprene cable and Schuko plug

Pantalla polietileno rotomoldeado Lámpara no incluida
Shade rotomoulded polyethylene Lamp not included

Lámpara no incluida *Lamp not included*

2375/016
2376/016
2377/016

 E27 LED

CE  IP45 

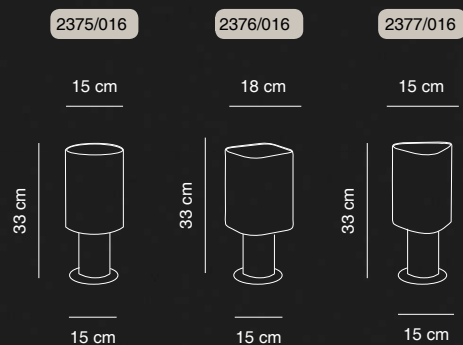



Stone Out Led

Design by Josep Puig & Josep Novell

Pantalla polietileno rotomoldeado
Shade rotomoulded polyethylene

Estructura acero inoxidable pintado blanco texturizado
Structure textured white painted stainless steel

No regulable
Not dimmable

Led integrado
Integrated Led

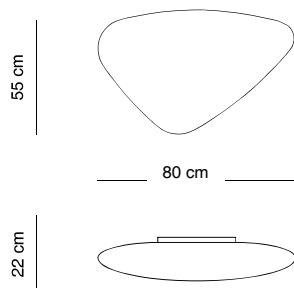

9330/036

LED Epistar 40W 3250lm 3000K CRI>80

CE IP 23







Stone Out Led

Design by Josep Puig & Josep Novell

Pantalla polietileno rotomoldeado
Shade rotomoulded polyethylene

Estructura acero inoxidable pulido/aluminio
Structure polished stainless steel/aluminium

No regulable
Not dimmable

Led integrado
Integrated Led

4 metros de cable con funda de neopreno y clavija Schuko
4 meters of neoprene cable and Schuko plug

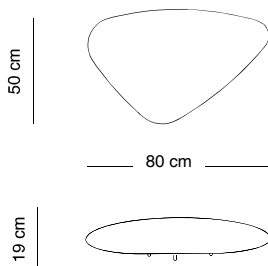

2300/036

LED Epistar 40W 3250lm 3000K CRI>80

CE   

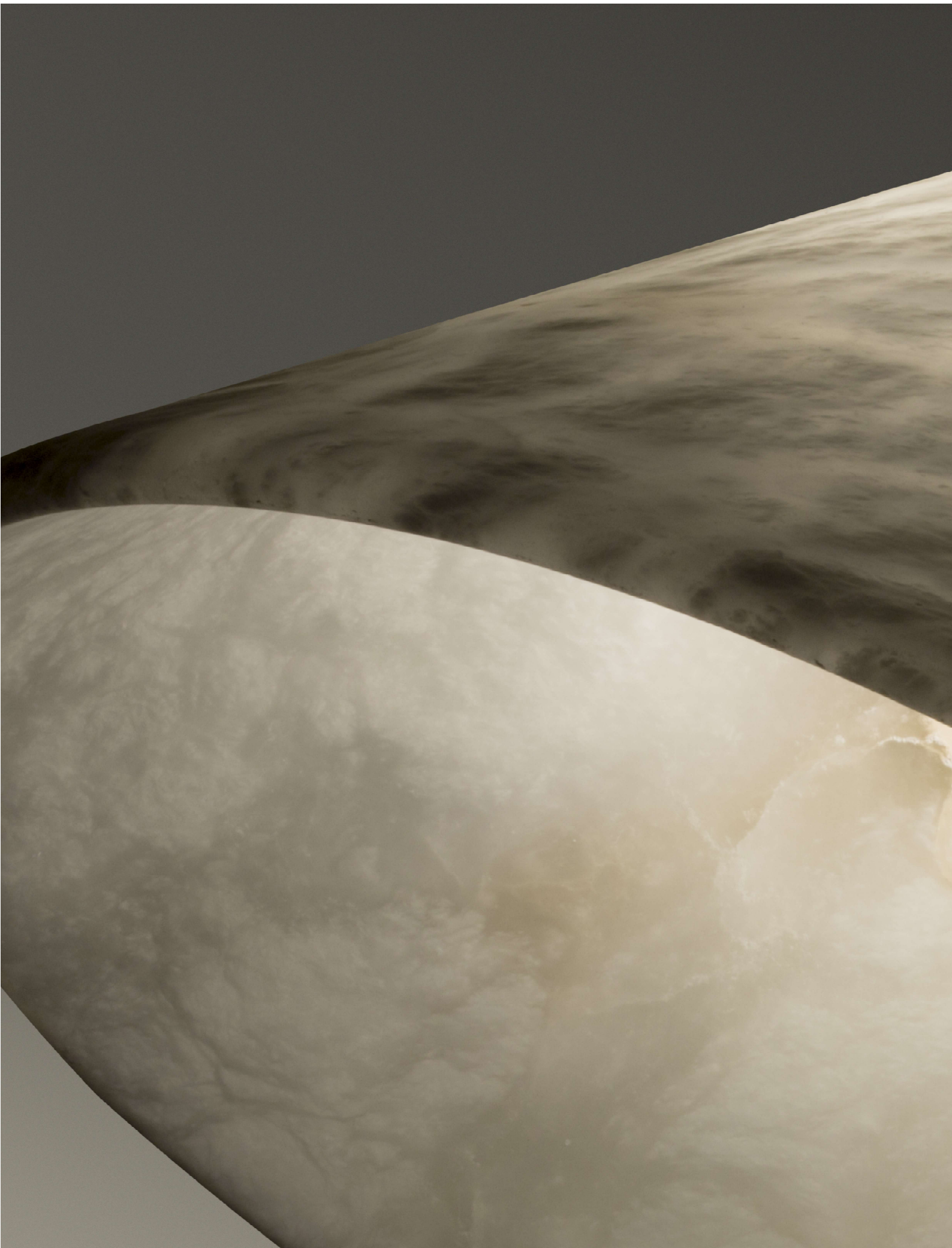



Pintura / *Painted*

Los colores de la paleta son aproximados
The colors in the palette are approximate

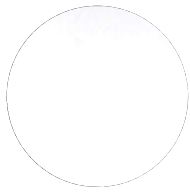

blanco mate
matt white

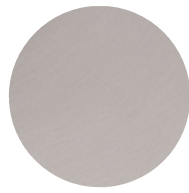

plata
silver



champagne
champagne

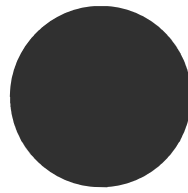

negro mate
matt black



dorado mate
matt gold

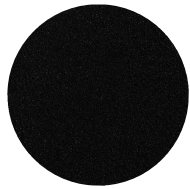

negro texturizado
textured black



corten texturizado
textured corten

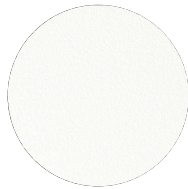

blanco texturizado
textured white



antracita texturizado
textured anthracite



negro brillante
glossy black



blanco brillante
glossy white

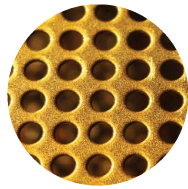

barniz dorado
varnish bronze

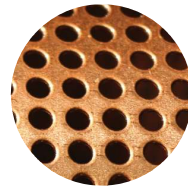

barniz bronce
varnish bronze

Pantallas de tela / *Textile shades*



polipropileno
polypropylene



almadén plata
silver almaden



algodón negro
black cotton



algodón blanco
white cotton

Cristal / *Glass*



transparente Deco
transparent Deco



negro Soft
black Soft



rosa Soft
pink Soft



blanco Soft
white Soft



borosilicato estriado
fluted borosilicate



borosilicato transparent
transparent borosilicate



triplex opal mate
opal triplex glass

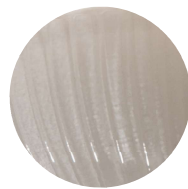

opal TheChandelier
opal TheChandelier

Baño electrolítico / *Electroplated*

Los colores de la paleta son aproximados
The colors in the palette are approximate



dorado satinado
satin gold



níquel satinado
satin nickel



bronce satinado
satin bronze

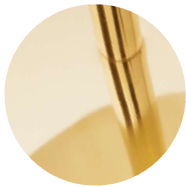

latón pulido brillo
polished brass



cromo
chrome

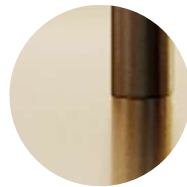

dorado brillo
polished gold

Anodizado / *Anodized*

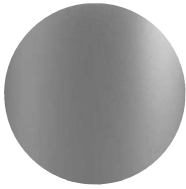

plata mate
matt silver

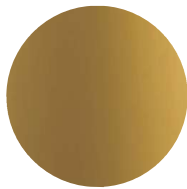

dorado mate
matt gold

Otros materiales / *Other materials*

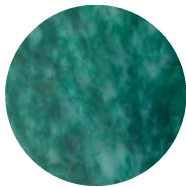

polietileno verde
green polyethylene



polietileno blanco
white polyethylene



polietileno rotomoldeado
rotomoulded polyethylene



metacrilato opal blanco
white opal methacrylate



metacrilato opal negro
black opal methacrylate



cerámica / arcilla
ceramics / clay



madera de Iroco
iroco wood



madera de roble
oak wood

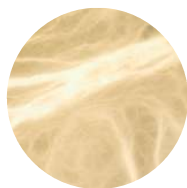

alabastro
alabaster



latón arenado
sandblasted brass

ALMA light
Barcelona





ALMA LIGHT se reserva el derecho a realizar modificaciones de producto sin previo aviso.
Catálogo realizado con papel ecológico, recíclelo, gracias

*ALMA LIGHT reserves the right to modify the products without prior notice.
Catalogue printed with ecological paper, please recycle it*

Fotografía / **Photography**

Tribeca USB

Cristina Gual Busqué,  Racó19, Sant Vicenç de Montalt (Spain)

Andrea Elballe & Pau Larrea,  La Rania, Vidrà (Spain)

Totem I, Tribeca, Star

 Cubiña, Barcelona (Spain)

PotLight

 Galería H2O, Barcelona

 Curvas fotométricas disponibles en www.almalight.com

Photometric curves available on www.almalight.com

Para acabados / colores distintos de los artículos catalogados, diseños especiales o formatos customizados, contactar con ALMA LIGHT
For finishes/colors different from the ones on this catalog, special designs or customized formats, please contact ALMA LIGHT



ALMALIGHT

Oficina central y almacén
Head office and warehouse

Cristobal de Moura 195-197
08019 Barcelona [Spain]

T [+34] 933 085 346
T [+34] 932 660 775
info@almalight.com

Follow us in Facebook
Instagram & Pinterest
@almalightbarcelona

www.almalight.com

